

Revision of the tribe Caenoculini (Insecta: Ephemeroptera: Caenidae) and its position within the Brachycercinae

Authors: Malzacher, Peter, and Sangpradub, Narumon

Source: Stuttgarter Beiträge zur Naturkunde A, 10(10) : 1-17

Published By: Stuttgart State Museum of Natural History

URL: <https://doi.org/10.18476/sbna.v10.a1>

Revision of the tribe Caenoculini (Insecta: Ephemeroptera: Caenidae) and its position within the Brachycercinae

PETER MALZACHER & NARUMON SANGPRADUB

Abstract

The tribe Caenoculini Sun & McCafferty, 2008 is revised, now including the genera *Caenoculis* Soldán, 1986, and *Tigrocercus* Malzacher, 2006. Improved diagnoses of these two genera are given. *Caenoculis dangi* Soldán, 1986 is transferred to the genus *Tigrocercus* and *Tigrocercus nastassjae* Malzacher, 2013 to the genus *Caenoculis*. *Caenoculis acutalis* Zhou, Sun & McCafferty, 2003 is regarded as representative of a separate genus *Brachoculis* **n. gen.** A diagnosis of the new genus is given. Relationships within the Brachycercinae are discussed.

Key words: Caenoculini, Brachycercini, Brachycercinae, *Brachoculis*, phylogeny.

Zusammenfassung

Der Tribus Caenoculini Sun & McCafferty, 2008 wird revidiert. Er umfasst nun die Gattungen *Caenoculis* Soldán, 1986 und *Tigrocercus* Malzacher, 2006. Von beiden Gattungen werden verbesserte Diagnosen erstellt. *Caenoculis dangi* Soldán, 1986 wird in die Gattung *Tigrocercus* und *Tigrocercus nastassjae* Malzacher, 2013 in die Gattung *Caenoculis* transferiert. *Caenoculis acutalis* Zhou, Sun & McCafferty, 2003 wird als eigene Gattung, *Brachoculis* **n. gen.**, betrachtet, für die eine Diagnose erstellt wird. Die Verwandtschaftsverhältnisse innerhalb der Brachycercinae werden diskutiert.

Contents

1	Introduction.....	1
2	Material and methods.....	2
3	Systematic account.....	2
	3.1 Genus <i>Caenoculis</i>	2
	3.2 Genus <i>Tigrocercus</i>	9
	3.3 Genus <i>Brachoculis</i> n. gen.	15
4	Discussion.....	15
5	References.....	17

1 Introduction

The genus *Caenoculis* was described by SOLDÁN (1986). In 2008, SUN & MCCAFFERTY revised the subfamily Brachycercinae and subdivided it into six tribes. The tribe Caenoculini was represented only by the genus *Caenoculis* with the three species *Caenoculis bishopi* Soldán 1986, *Caenoculis nhahoensis* Soldán 1986, and *Caenoculis acutalis* Zhou, Sun & McCafferty 2003. SUN & MCCAFFERTY removed *Caenoculis dangi*, also described by SOLDÁN (1986), from *Caenoculis* and placed it in the genus *Caenis* because of some *Caenis*-like characters in the description of SOLDÁN.

The subfamily Madecocercinae including the genera *Afrocerus* Malzacher, 1987 and *Madecocercus* Malzacher, 1995 was established by MCCAFFERTY & WANG in 2000 as sistergroup of Brachycercinae. When MALZACHER & STANICZEK (2006) revised Madecocercinae they also described the new genus *Tigrocercus* based on imagines. As larvae of *Tigrocercus* were unknown at that

time, the new genus was placed within Madecocercinae (MALZACHER & STANICZEK 2006).

From *Caenoculis* only larval stages were described (SOLDÁN 1986, ZHOU et al. 2003). Since then, new material from numerous sources became available for this investigation (see below). As a result, several new characters were available to allow the description of the so far unknown males of *Caenoculis* and for revising the tribe Caenoculini sensu SUN & MCCAFFERTY (2008).

Acknowledgements

We are indebted to all colleagues who left us material for investigation, in particular KAI SCHÜTTE (Hamburg), MICHEL SARTORI (Lausanne), JAN PETERS (Thallahassee), SYLVESTER OGBOGU (Ile-Ife), and ROMAN GODUNKO (České Budějovice and Lviv). Thanks are also due to SUSANNE LEIDENROTH and KARIN WOLF-SCHWENNINGER (Staatliches Museum für Naturkunde, Stuttgart) for making the SEMs, and to ARNOLD STANICZEK (Stuttgart) and MICHEL SARTORI (Lausanne) who kindly read the manuscript and provided valuable suggestions.

2 Material and methods

The material used for this study comes from numerous collections: The ULMER collection housed at the Zoologisches Museum Hamburg (see also MALZACHER 2015), material from Nigeria (collected by SYLVESTER OGBOGU, Ile-Ife, Nigeria, now in coll. MALZACHER) and finally from Thailand (besides a few specimens from the coll. JAN PETERS, FAMU, Tallahassee), an extensive material collected by one of us (SANGPRADUB). Also available for this study were the type specimens of *Caenoculis* deposited at FAMU, Tallahassee, and at the Institute of Entomology in Ceske Budejovice, Czech Republic. All specimens are preserved in 75 % ethanol.

The abbreviations used on labels of the coll. SANGPRADUB refer to provinces, rivers or National Parks of Thailand: CYP = Prov. Chaiyaphum, KKJ = Kaeng Krachan National Park, LOI = Prov. Loei, MUN = Mun River, MRC = Mekong River, NKK = Prov. Nakhon Ratchasima, PCB = Prov. Petchabun, POG = Phong River, SKK = Prov. Sakon Nakhon, SKP = Prov. Nakhon Phanom.

Specimens used for SEM were dehydrated through a step-wise immersion in ethanol and then dried by critical point drying. The mounted material was coated with a 20 nm Au layer, examined and photographed with a Zeiss EVO LS 15 scanning electron microscope. Digital photographs were enhanced by using Photofiltre 6.5.2 (<http://www.photofiltre-studio.com>).

3 Systematic account

3.1 Genus *Caenoculis*

Type species: *Caenoculis bishopi* Soldán, 1986.

Differential diagnosis

The genus *Caenoculis* can be distinguished from all other genera of Caenidae by the following combination of characters: L a r v a : Cuticle, dorsal and ventral side, densely covered with shield-shaped microtrichia (Figs. 6, 7). – Ocellar tubercles moderately domed (Fig. 6). – Maxillary and labial palps three-segmented. – Pronotum 2.5–2.8 times as wide as length of lateral sides. – Lateral processes on abdominal segments IV–VII (Fig. 3d); processes not bent dorsally. – Abdominal terga I and II each with a posteromedial process (Figs. If, j, o, r). – Sternum IX posteromedially more or less protruding (Figs. 1a, h, k, p). – Operculate gills with protruding posterolateral corner. – Ventral side of operculate gill with a band of microtrichia proceeding in a distance from the lateral margin of the gill (Figs. 1c, i, l, q and 9). – The band consisting of short transverse rows, more or less dispersed in their posterior part (Fig. 10). – Surface between microtrichia band and margin of gill scattered with special microtrichia that resemble the shape of a slim finger or a pine needle (Figs. 11, 12). — M a l e : Tarsomere 2 of fore leg clearly longer as 3. – Fore coxae widely separated, prosternum broad, with two transverse ridges. – Trochanter of fore leg elongated. – Mesonotum anterior to short mesonotal membrane abruptly lowered (Fig. 3i). – Lateral filaments on abdominal segments IV–VII (Fig. 2j). – Abdominal terga I and II each with a finger like process (Fig. 2i). –

Lateral margins of segment IX and lateral sclerites parallel, the latter with S-shaped keel (Figs. 2a, c). – Penis with a median, tongue-like structure on ventral side, with two more or less developed paramedian processes (Figs. 2a, c). – Forceps long and sickle-shaped, apical half very narrow, with one or two longitudinal ridges (Figs. 2b, d). – Forceps muscle well developed.

Remarks

When I examined the above mentioned type specimens, the ULMER material, and the few specimens I received from JAN PETERS, I found a couple of new diagnostic characters that seemed to allow for a redescription of the species *Caenoculis bishopi* Soldán, 1986 and *Caenoculis nhahoensis* Soldán, 1986 and also the description of two new species of this genus. Investigation of all available larval material of *Caenoculis* revealed that all previously used characters for species discrimination within this genus are in fact highly variable, even occurring in nearly all conceivable combinations within single populations.

Under these circumstances a description of *Caenoculis* species based on larval characters seems to be impossible (see also Discussion). Hence I can give only a description of all common characters of the genus and their variability. For an identification that may become possible in the future by new knowledge and methods I redescribe the type specimens of *Caenoculis bishopi* and *Caenoculis nhahoensis*. Available males and subimago male genitalia from last instar larvae are described.

General morphology of larvae of *Caenoculis*

Material examined

Holotype of *Caenoculis bishopi*, ♀ larva, Malaysia, Trib. of Gombak R., N. of Kuala Lumpur, 12.XII.1968, J. BISHOP leg.

Holotype of *Caenoculis nhahoensis*, ♀ larva, Vietnam, Kinh-Dinh Riv., Phan Rang, Nha-ho, 18.IV.1982, T. SOLDÁN leg. – Paratypes, 3 larvae, same data as holotype.

Vietnam, Lam Dong Prov., Da Prenn, Dalat, 26.X.1984, 3 larvae, T. SOLDÁN leg.

Indonesia, Java, Tjobodas, Kali Tjiwalen, 10.VII.1929, 5 larvae, coll. G. ULMER. – Same locality, 13.VII.1929, 1 larva.

PCB 2.1, Thailand, Petchabun Prov., Huai Hin Lad, Nam Nao National Park, 12.II.1998, 4 larvae, leg. N. SANGPRADUB (as all following samples). – PCB 2.2, same locality, 11.II.1998, 1 larva. – PCB 3.4, Thailand, Petchabun Prov., Phromlaeng, Nam Nao National Park, N16°38'24.02", E101°34'52.90", 09.IV.2013, 3 larvae. – PCB 4.1, Thailand, Petchabun Prov., Phromsong, Nam Nao National Park, N16°34'09.30", E101°34'04.80", 08.VI.2013, 3 larvae. – PCB 5.1, Thailand, Petchabun Prov., Yakraue, Nam Nao National Park, N16°44'21.60", E101°34'28.84", 09.VI.2002, 1 larva. – PCB 6.1, Thailand, Petchabun Prov., Tum Pu Hin Lek Fai, Nam Nao National Park, 07.II.1996, 1 larva. – PCB 6.2, same locality, 21.V.1996, 1 larva. – KKK 1.3, Thailand, Kanchanaburi Prov., Pa La Au3, Kaeng Krachan National Park, 13.I.2009, 1 larva. – NKK 1.1, Thailand, Nakhon Ratchasima Prov., Wang Tao Waterfall, Thap Lan National Park, N14°20'12.13", E102°14'33.69", 27.IV.2014, 2 larvae. – SKP 1.4, Thailand, Nakhon Phanom Prov., Tat Pho Waterfall,

N17°57'46.58", E104°08'24.39", 23.IX.2012, 1 larva. – SKP 2.1, same data, 1 larva.

Colouration of cuticle: Head, pro and mesonotum, operculate gills and legs brown, with 1 pale spot on vertex, lateral parts of pronotum, and on base of wing pads. Abdominal terga a little lighter than head and thorax.

Epidermal pigmentation: a transverse band on vertex and median parts of pronotum blackish grey. Central field of operculate gills with black speckles that can flow together forming a black field with a few light spots.

Cuticle: Dorsal and ventral side densely covered with shield-shaped microtrichia (Figs. 6, 7) more or less stalked, stalks not visible in frontal view, margins of these

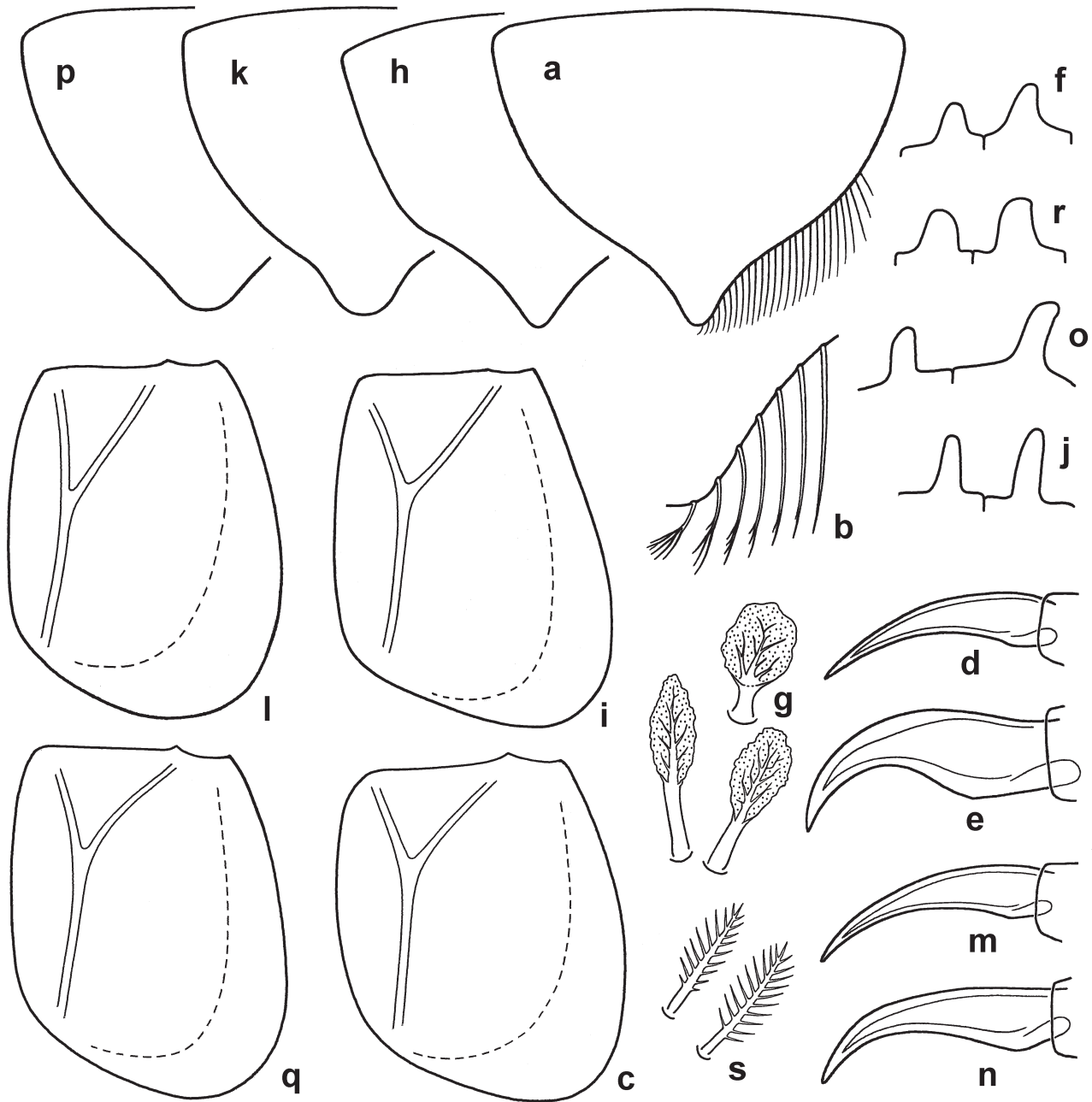

Fig. 1. *Caenoculis nhahoensis* (a–g), *Caenoculis bishopi* (h–j), *Caenoculis* sp. (Java) (k–o), *Caenoculis* sp. (Northern Vietnam) (p–s), larva. – a, h, k, p. Segment IX. – b. Segment IX, setation of posterior protrusion. – c, i, l, q. Operculate gill. – d, m, n. Fore claw. – e, n. Mid claw. – f, j, o, r. Posteromedial processes on abdominal terga I and II (lateral view, tergum I left). – g. Operculate gill, tree-shaped microtrichia from lateral margin. – s. Abdomen, pinnate bristles from dorsal side of lateral processes.

microtrichia are denticulated or smooth. In lateral view, bristles often have a bush- or tree-like outline (Fig. 8). Marginal parts of the body are provided with thin long bristles, similar bristles often scattered on the surface.

Head: Hind margin with moderate bristles (Fig. 6). Genae not bulging out. Lateral ocellar tubercles more or less triangularly rounded in frontal or posterodorsal view. Maxillary palp and segment 3 of labial palp relatively short.

Thorax: Sides of pronotum straight, parallel or slightly converging anteriorly. Pronotum 2.5–2.8 times as wide as length of the parallel lateral sides. Pro- and mesonotum with a median longitudinal ridge or keel, often densely covered with bush- or tree-shaped microtrichia.

Coxal processes inconspicuous, forming more or less sclerotized smooth edges. Femora and tibiae densely covered with shield-shaped microtrichia, often also with bush- or tree-shaped ones (Fig. 8), with long and thin marginal bristles. Tarsi ventrally with a row of 10–20 acute bristles; similar bristles also apically on tibiae. Claws without denticles, apical part of mid and hind claws more or less bent. (Figs. 1d, e, m, n).

Abdomen: Abdominal segments IV–VII with long and bowed lateral processes; other segments without processes (Figs. 3d). Lateral bristles long and numerous. Dorsal side of processes IV–VI(VII) provided with 15–20 bipinnate bristles (Fig. 1s). Abdominal terga I and

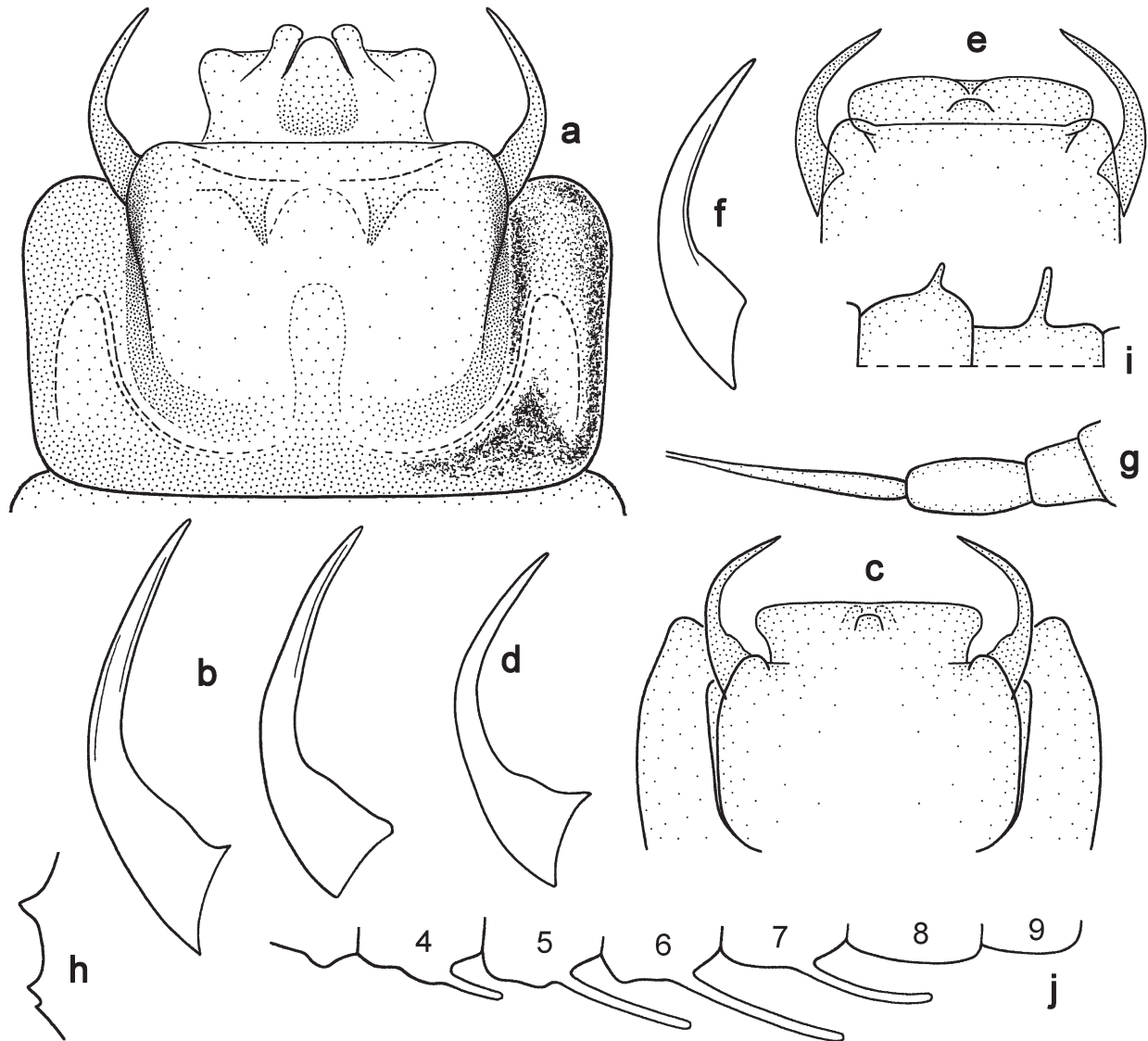

Fig. 2. *Caenoculis* sp. (Thailand), male imago (a, b, g–j). – *Caenoculis* sp. (Thailand), last instar male larva (c, d). – *Caenoculis* sp. (Java), last instar male larva (e, f). – a. Sternum IX with genitalia. – b, d, f. Forceps. – c, e. Subimaginal genitalia. – g. Male, antenna, scape, pedicel and base of flagellum. – h. Prosternum, lateral view. – i. Abdominal terga I and II, lateral view. – j. Lateral outline of abdomen.

II each with a posteromedial process. Both processes very variable in length, width and in their relative position to each other (Figs. 1f, j, o, r). Hind margin of tergum VII with very long bristles, surface without microtrichia. Tergum VIII with a few long bristles, most of them laterally. Terga VIII–X densely covered with shield-shaped microtrichia, on posterior part and hind margin often bush- or tree-shaped. Sternum IX posteriorly more or less protruding, varying from broadly rounded to elongated and triangularly pointed (Figs. 1a, h, k, p). Posterior half of margin densely provided with long bristles, the most posterior ones shortened, bent medially and more or less pinnate (Fig. 1b). Operculate gills with protruding posterolateral corner, different shapes in Figs. 1c, i, l, q. Sides and hind margin with moderate and long bristles, the longest posterolaterally and on hind margin. Ridges on dorsal side of operculate gill well developed, more or less keeled. Inner field between longitudinal ridge and median margin without shield-shaped microtrichia but often with microtrichia of pine needle type (see below). Operculate gill on ventral side with a band of microtrichia proceeding in a (variable) distance from lateral margin to the posteromedial

corner (Figs. 1c, i, l, q and 9). The band consists of transverse rows of microtrichia more or less dissolved in their posterior part (Fig. 10). Band of microtrichia marginally with microtrichia of pine needle type closely lying against the surface (Figs. 10–12). Most of them are arranged more or less radially. They are articulated more or less acentrically. At point of articulation, bristles are often slightly dilated (arrows in Figs. 11, 12).

Caenoculis bishopi Soldán, 1986
(Figs. 1h–j)

SOLDÁN (1986: 348); SUN & McCAFFERTY (2008: 21).

Material examined

Holotype, ♀ larva, Malaysia, Trib. of Gombak R., N. of Kuala Lumpur, 12.XII.1968, J. BISHOP leg.

Larva

Measurements and colouration

Holotype, female larva, subadult: body length 4.1 mm, length of cerci 2.1 mm. – Head, thoracic nota and operculate gills intense yellowish-brown. Abdomen a little lighter. Legs and cerci yellowish.

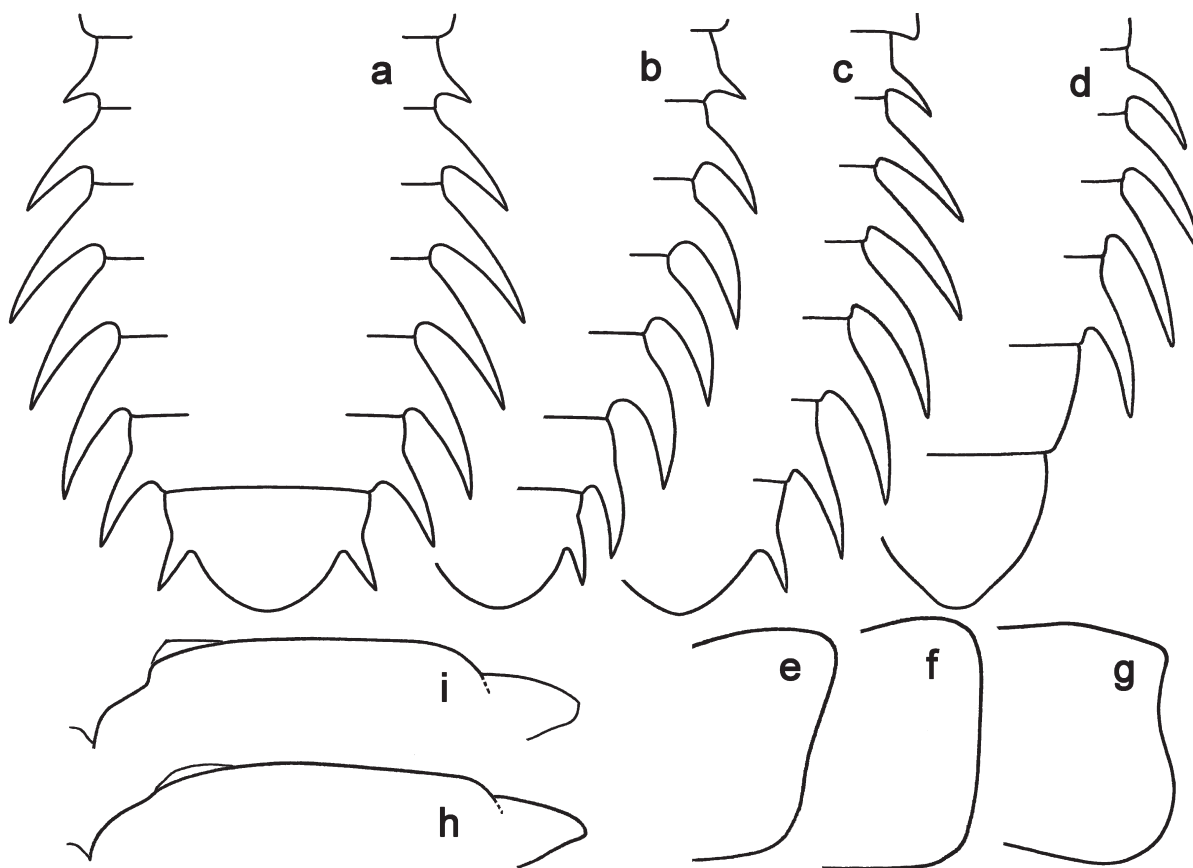

Fig. 3. *Tigrocercus dangi* (a, f, h), *Tigrocercus* sp. POG 3.1 (b, g), *Tigrocercus* cf. *contractus* (c, e), *Caenoculis* sp. (d, i). – a–d. Larva, lateral outline of abdomen. – e–g. Larva, lateral part of pronotum. – h, i. Imago, outline of mesonotum, lateral view.

Morphology

Cuticle: Margin of shield-shaped microtrichia smooth (SUN & McCAFFERTY 2008: fig. 43). Microtrichia on ridges and margins with short stalks (bush-shaped) or without; well developed tree-shaped bristles on posterior part of abdominal terga VIII–X and on lateral and posterior margins of operculate gill. – **Head:** Tubercles of lateral ocelli well developed, triangular in posteromedial view, with rounded tip, frontal ocellus smaller. Fore margin of labrum slightly concave. Segment 3 of maxillary palp about 1.5 times as long as segment 2. Segment 2 and 3 of maxillary palp about 1.2 times as long as segment 2 and 3 of labial palp. Segment 2 of labial palp about 1.7 times as long as segment 3. – **Thorax:** Pronotum and anterior fourth of mesonotum with a well developed median ridge flattened in the posterior part of mesonotum and provided with small, round microtrichia. Fore claws slender and slightly bowed, mid and hind claws basally broad and apically bowed. – **Abdomen:** Lateral processes comparatively long and slender, processes V and VI on inner margin each about 1.6 times as long as the respective segment. Posteromedial process on terga I and II straight, long

and slender, process on tergum I slightly shorter and narrower (Fig. 1j). Sternum IX with lateral sides more or less abruptly bent, posteriorly forming a triangle with concave sides and pointed tip (Fig. 1h). Posterolateral part of operculate gill strongly protruding laterally. Maximal width about 1.7 times length of anterior margin (Fig. 1i). On ventral side of operculate gill, anterior and median part of microtrichia band with numerous irregularities, in the posterior part transverse rows largely dispersed. Only a few microtrichia of pine needle type on the surface between band of microtrichia and gill margin. On dorsal side numerous very long microtrichia of pine needle type in the field between inner margin and longitudinal ridge.

Caenoculis nhahoensis Soldán, 1986

(Figs. 1a–g)

SOLDÁN (1986: 352).

Material examined

Holotype, ♀ larva, Vietnam, Kinh-Dinh Riv., Phan Rang, Nha-ho, 18.IV.1982, T. SOLDÁN leg. – Paratypes, 3 larvae, same data as holotype.

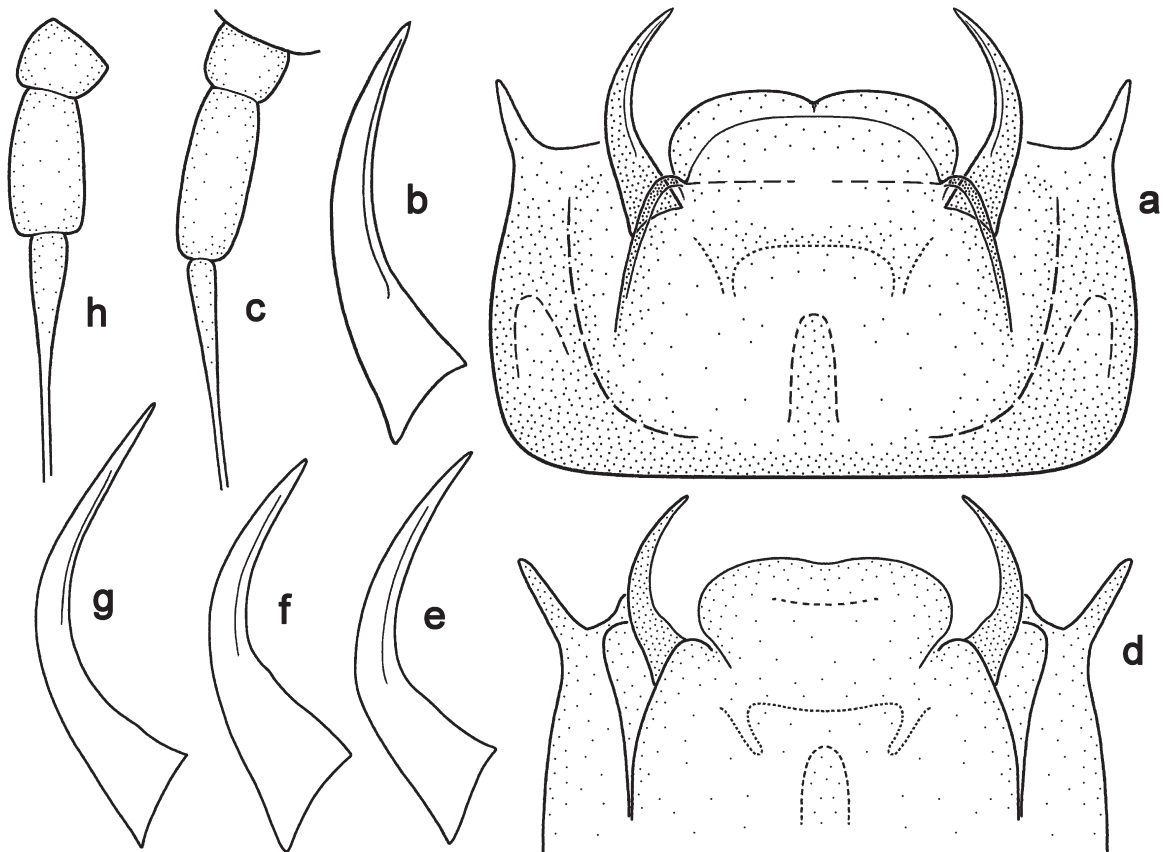

Fig. 4. *Tigrocercus dangi*, male (a–c), last instar male larva (d–h). – a, d. Sternum IX with genitalia. – b, e–g. Forcipes. – c, h. Scape, pedicel and bas of antennal flagellum.

Larva

Measurements and colouration

Holotype, female larva, subadult: body length 4.1 mm, length of cerci 2.5 mm. Male larva subadult, body length 3.4 mm, length of cerci 2.5 mm. – Body brown. Operculate gills with paler yellowish spots and irregular marks. The colouration is caused by the brown shield-shaped microtrichia, yellowish parts are covered with paler microtrichia. Legs and cerci yellowish-brown.

Morphology

B o d y : broad and relatively flat. – **C u t i c l e** : Besides the shield-shaped microtrichia, particularly ridges and margins are densely provided with long, stalked, tree-shaped microtrichia (Fig. 1g). – **H e a d** : Tubercles of lateral ocelli triangular in posteromedial view, with rounded tip, frontal ocellus smaller. Fore margin of labrum slightly concave. Segment 3 of maxillary palp about 1.3 times as long as segment 2. Segment 2 and 3 of maxillary palp about

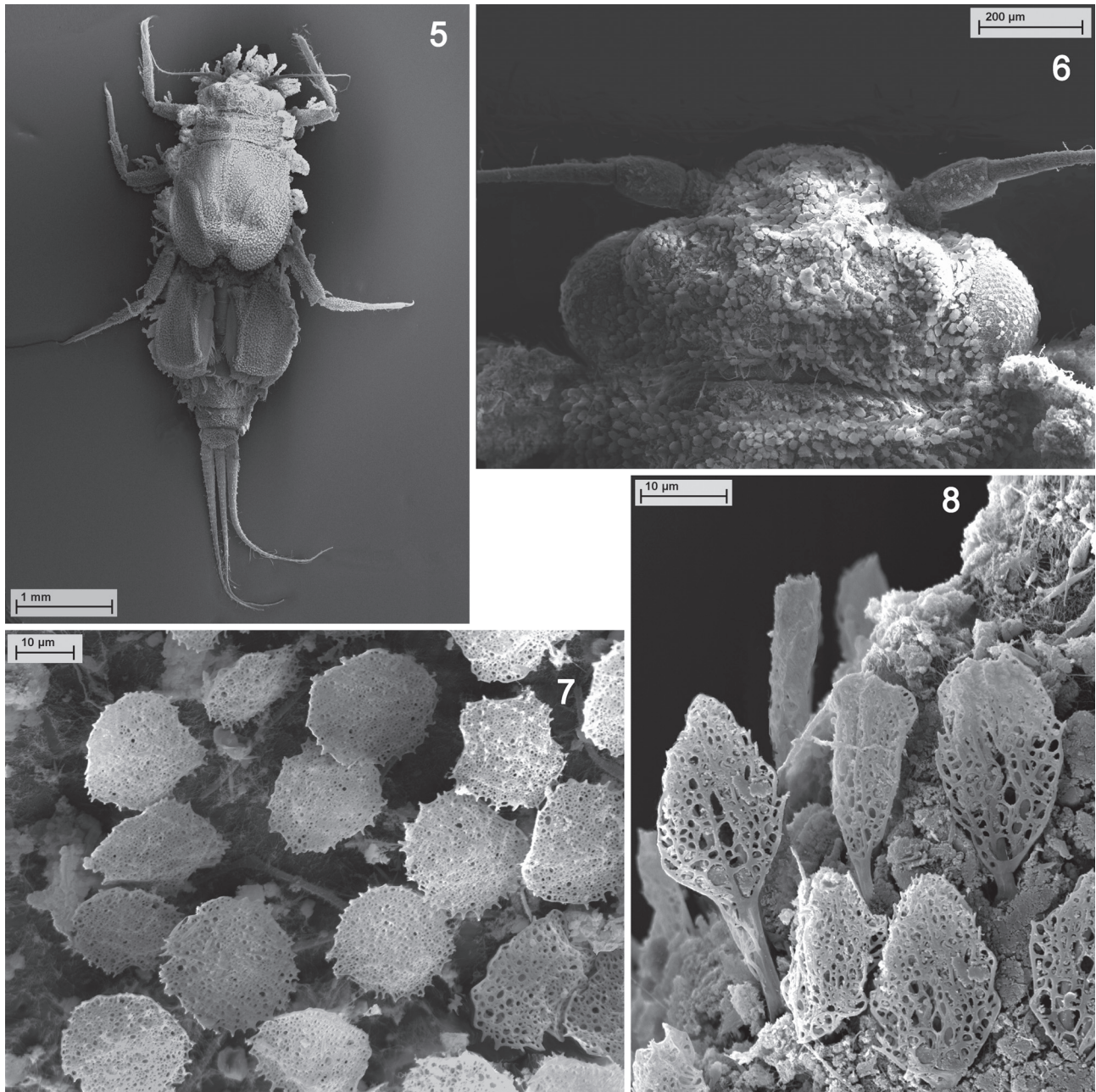

Figs. 5–8. *Caenoculis* sp. (Java), larva. – 5. Habitus. 6. Head, bristles removed. 7. Circular microtrichia on dorsal side of operculate gill. 8. Operculate gill, bush- and tree-shaped microtrichia.

1.2 times as long as segment 2 and 3 of labial palp. Segment 2 of labial palp about 1.4 times as long as segment 3. – **T h o r a x** : Pro- and mesonotum medially strongly keeled. Keels densely provided with long tree-shaped microtrichia. Fore claws slender and slightly bowed, mid and hind claws basally broad, apically strongly bowed (Figs. 1d, e). – **A b d o m e n** : Lateral processes relatively broad, processes V and VI on inner margin each about 1.3 times as long as the respective segment. Posteromedial process of terga I and II basally broad, apically slightly bent posteriorly (Fig. 1f). Both processes provided with numerous tree-shaped microtrichia. Tree-shaped microtrichia on terga VIII–X very long. Sternum IX ending in a long triangular and pointed protrusion, sides S-shaped, bristle on tip of protrusion apically frayed (Figs. 1a and b). Gill I hardly half as long as gill cover. Operculate gill broad, anterior part (without posterolateral protrusion) square; maximal width about 1.4 times length of anterior margin (Fig. 1c). Ridges and lateral and hind margins densely provided with well developed tree-shaped microtrichia. Anterior part of band of microtrichia on ventral side consisting of short transverse rows of about 3 microtrichia (as Fig. 10 left), posteriorly the rows becoming more and more irregular, peripherally often with single spines or clusters of 2–3 spines; near hind margin transverse rows more or less dispersed (as Fig. 10 right). Microtrichia of pine needle type on the entire surface between band of microtrichia and gill margin. Similar microtrichia also on dorsal side of gill, for the most part covered by shield-shaped microtrichia. Gills III(–V) with about 15 filaments with 3 branches.

Males of the genus *Caenoculis*

Remarks: Two males from Thailand allow for the description of the so far unknown imaginal stages of the genus, supported by two last instar male larvae from Thailand and Java, with visible subimaginal characters as genitalia, shape of antenna, prosternum and proportion of fore leg tarsomeres. The variable larval morphology does not allow for an assignment to a certain species.

Caenoculis sp.

(Figs. 2a, b, g–j)

Material examined

Thailand, Loei Prov., Na Heaw National Park, Namtok Tat Huang, N17°33', E100°59', 9.XI.2002, 1 ♂, coll. J. PETERS. – Thailand, Kiang Mai Prov., Doi Intanos National Park, NT Huai Sai Leung, N18°31', E98°27', 3.III.2002, 1 ♂, coll. J. PETERS.

Measurements and colouration

Body length: 3.0–3.5 mm; wing length: 3.0–3.3 mm; length of fore leg: 2.5–2.8 mm. Ratio of fore femur : fore tibia = 0.51–0.54; ratio of fore tibia : fore tarsus = 1.25–1.41; ratio of fore leg : hind leg = 1.93–2.06; ratio of segments of the fore tarsus: 1st : 2nd : 3rd : 4th : 5th = 1 : 4.2–4.5 : 2.2–2.5 :

2.4–2.6 : 2.3–2.4. – Colouration of cuticle: Metanotum tobacco-brown; other parts light brownish-yellow. – Epidermal pigmentation: Frons and anterior vertex blackish-brown, posterior vertex more or less lightened. Pronotum blackish-brown with two paramedian longitudinal light stripes and two sublateral circular greyish marks. Mesonotum with grey sutures, median notal suture blackish, scutellum with a blackish-brown pattern. Metanotum and abdominal terga with grey to blackish-brown transverse bands and paratergal spots and dashes. Ventral side, legs, and cerci shaded with grey. Base of postmentum and two transverse dashes on prosternum blackish-brown.

Morphology

H e a d : Antennal flagellum basally dilated (Fig. 2g). Dilated part very long, 1.5 times length of pedicel; pedicel 2.5 times as wide as dilatation. – **T h o r a x** : Distance from wing tip to cross vein R1-R2 1.3–1.4 times of distance from cross vein R1-R2 to middle of costal brace. Fore coxae widely separated, prosternum broad, with two transverse ridges, median part of the posterior ridge doubled (lateral view Fig. 2h). Trochanter of fore leg elongated. Mesonotum anterior to the short mesonotal membrane abruptly lowered (Fig. 3i). Metanotum without transverse ridge, hind margin with a very small, broadly triangular membrane. – **A b d o m e n** : Very long lateral filaments on abdominal segments V–VII, shorter ones on segment IV (Fig. 2j). Abdominal tergum II with a median finger-like process, another very short process on tergum I (Fig. 2i). – **Genitalia and sternum IX** as in Fig. 2a. Penis with moderate broadly rounded lobes, on ventral side with a median tongue-like structure and two paramedian processes basally broadened and apically rounded and projecting over the hind margin of penis; the median tongue more or less brownish. Styliiger sclerite paramedially with two long and triangular apophyses. Lateral sclerites parallel, strongly sclerotized and keeled, keels weakly S-shaped. Forcipes long and sickle-shaped, apical half narrow, with one or two longitudinal ridges, basal part more or less abruptly broadened, inner margin without denticles (Fig. 2b). Forceps muscle well developed.

Caenoculis sp.

(Figs. 2e, f)

Material examined

Indonesia, Java, Tjobodas, Kali Tjiwalen, 10.VII.1929, 2 last instar male larvae, coll. G. ULMER.

Base of antennal flagellum moderately dilated. Fore coxae widely separated, prosternum broad, with two transverse ridges. Tarsomere 2 of fore leg clearly longer than the others. Abdomen with long lateral filaments on segments IV–VII (as in Fig. 2j). Penis with short rounded lobes, with a median, tongue-like structure on ventral

side; lateral sclerites parallel (Fig. 2e). Forcipes long and sickle-shaped, basally broadened, medio-apical part with a longitudinal ridge. (Fig. 2f).

Caenoculis sp.
(Figs. 2c, d)

Material examined

SKP2.1, Thailand, Nakhon Phanom Prov., Tat Pho Waterfall, N17°57'46.58", E104°08'24.39", 23.IX.2012, 1 last instar male larva, N. SANGPRADUB leg.

Most characters like above. Genitalia as in Fig. 2c. Penis besides the tongue-like structure with two small and inconspicuous paramedian processes. Basal third of forceps broadened with inner margin bulged (Figs. 2d), towards apex abruptly constricted, apical two thirds of forceps very thin.

Caenoculis nastassjae Malzacher, 2013, **n.comb.**
MALZACHER (2013: 39, sub *Tigrocercus nastassjae*).

The species is only known from a male imago. For a detailed description see MALZACHER 2013: 39, figs. 10a–d, 13i, 48. These figures confirm the species as a member of the genus *Caenoculis* and show that it is not identical with the males described above (see Discussion).

3.2 Genus *Tigrocercus*

Type species: *Tigrocercus contractus* Malzacher, 2006.

Differential diagnosis

The genus *Tigrocercus* can be distinguished from all other genera of Caenidae by the following combination of characters: L a r v a : Cuticle densely covered with shield-

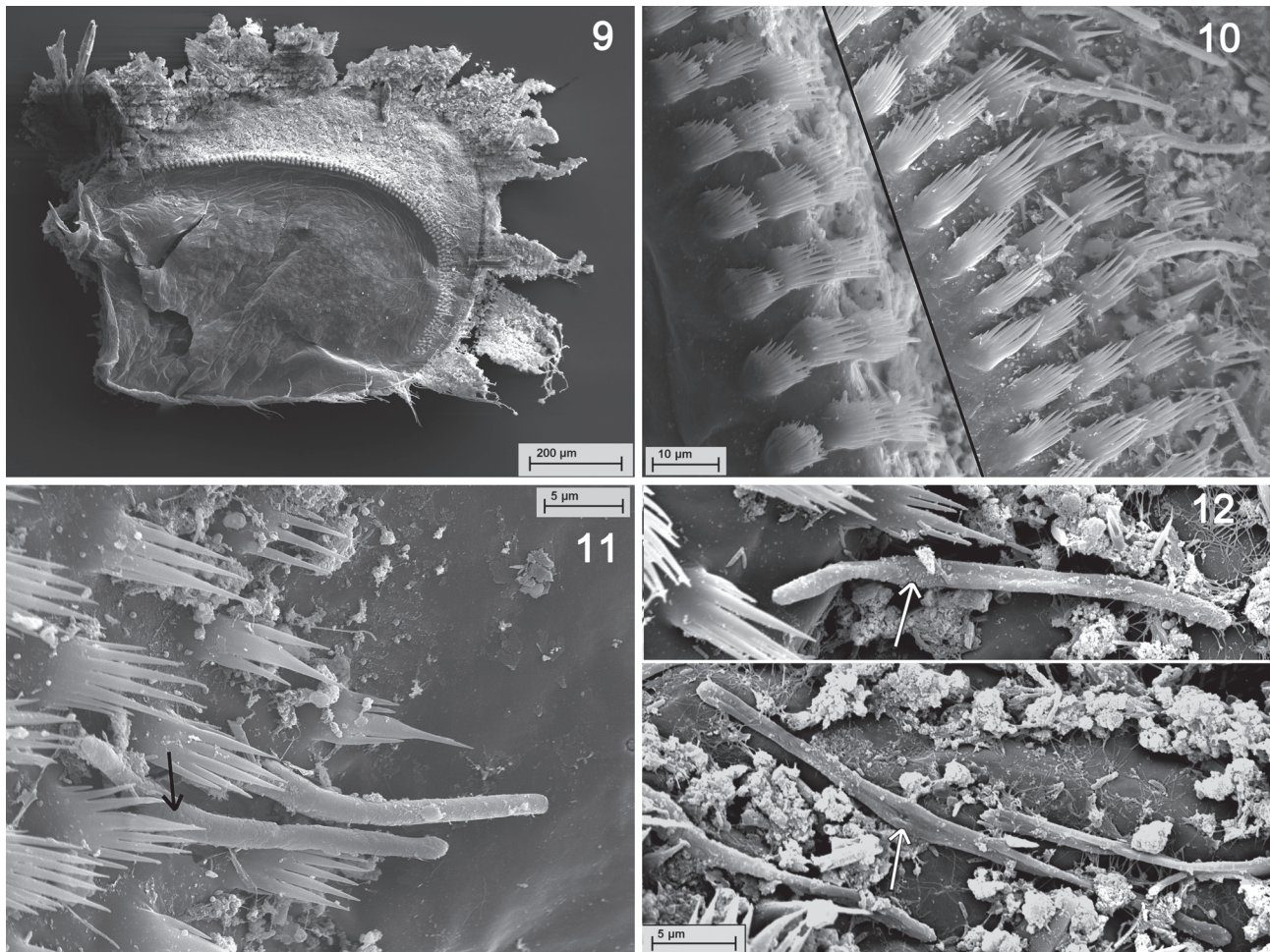

Figs. 9–12. *Caenoculis* sp. (Java), larva. – 9. Operculate gill, ventral view. 10. Operculate gill, band of microtrichia from ventral side, sector from anterior part of the band (left) and from posterior part (right). 11. Ventral side of operculate gill, scale-shaped and pine needle-shaped microtrichia in higher magnification. – Arrow: articulation point of pine needle-shaped microtrichia. 12. Ventral side of operculate gill, different pine needle-shaped microtrichia. – Arrows: articulation point.

shaped microtrichia. – Ocelli slightly domed or not domed at all. – Maxillary and labial palps three-segmented. – Pronotum 3.0–3.5 times as wide as length of lateral sides. – Lateral processes on abdominal segments III–IX (Figs. 3a–c); processes not bent dorsally. – Ventral side of operculate gill with a band of microtrichia consisting of regular, compact, transverse rows, clearly separated from each other (Figs. 18–21). – No microtrichia of pine needle type on surface between band of microtrichia and margin. – Sternum IX without posterior protrusion (Figs. 3a–c). — **Male**: Tarsomeres 2–5 subequal in length. – Fore coxae widely separated, prosternum broad. – Trochanter of fore leg elongated. – Mesonotum anterior to short mesonotal membrane only slightly lowered (Fig. 3h). – Lateral sclerites posteriorly converging, without S-shaped keel (Fig. 4a). – Penis without tongue-like structure (Fig. 4a). – Forceps long and sickle-shaped, more or less evenly broadened to the base; apically with one longitudinal ridge (Figs. 4b, e–g). Forceps muscle well developed. — **Egg**: Chorion with six longitudinal rows of scales (Fig. 22).

Tigrocercus cf. contractus
(Figs. 3c, e)

Material examined
Nigeria, Opa stream, Ife, XII.2006, 1 larva.

Larva

Measurements and colouration

Subadult larva, body length 3.3 mm, length of cerci 2.5 mm. – Colouration of cuticle: Light yellowish-brown. Epidermal pigmentation: grey or blackish pigments on head between lateral ocelli, on central part of pro and mesonotum; transverse bands on metanotum and abdominal terga. Gills 3–6 with strongly blackish bases, filaments less pigmented.

Morphology

Cuticle: Dorsal side densely covered with circular microtrichia. – **Head**: Without ocellar tubercles. Clypeus with numerous long bristles, a couple of long and thin bristles also on frons and vertex. Genae not bulging out. Pedicel ventrally with 15–20 strong bristles of moderate length. Two paramedian groups of tree-shaped microtrichia between lateral ocelli. Mandibles with a dorsolateral field of long thin bristles. Maxillary palp relatively short, segments 2 and 3 scarcely longer than labial palp segments 2 and 3. Segment 2 of labial palp about 1.8 times as long as segment 3. Surface of labium, particularly postmentum, with long bristles. – **Thorax**: Pronotum about 3.5 times as wide as length of lateral sides. Lateral margins anteriorly diverging, more or less concave (Fig. 3e). Basal two thirds of fore femur on dorsal side with a longitudinal row of thin bristles, in the apical third broadened, forming a group of thin bristles, a few of

them clearly shorter than remaining ones. Coxal processes inconspicuous, narrow, sickle-shaped. Femora and tibiae marginally and dorsally with very long hair-like bristles, a few bristles even on ventral side. Tarsi ventrally with an irregular row of about 10 short and pointed bristles. Fore claws slender and slightly bowed, mid and hind claws apically strongly bent, all claws without denticles. – **Abdomen**: Abdominal segments III–IX with lateral processes, IV–VIII long and bowed, III and IX shorter (Fig. 3c). All processes with numerous long bristles, processes IV–VII with a dorsolateral row of short, blunt, and apically pinnate bristles (not on process VIII). Posteromedial process of tergum II long and cone-shaped, densely covered with circular microtrichia. Hind margin of terga VII and VIII with very long hair-like bristles, of terga IX–X smooth (not denticulated as in most *Caeninae*). Hind margin of sternum IX triangular with rounded tip (Fig. 3c), with long bristles, the median ones medially bent. Gill I more than half the length of gill cover. Operculate gill with long and very long bristles on lateral and hind margins, inner margin with shorter bristles. Y-shaped ridges well developed, median ridge with long, thin bristles. Band of microtrichia on ventral side of operculate gill consisting of transverse rows of 2–3 short microtrichia, rows 1.5–2 times as long as width of basal microtrichium (Fig. 18). Most filaments of gills III–V with 3 or 4 branches.

Tigrocercus dangi **n. comb.**
(Figs. 3a, f–h, 4, 13–24)

SOLDÁN (1986: 350, sub *Caenoculis dangi*).

Material examined

Holotype, ♀ larva, Vietnam, Cau Song Pha, 50 km W. of Phan Rang, 20.IV.1982, T. SOLDÁN leg.

Thailand, Nan Prov., Mae Charim National Park, Nam Wa Riv., N18°36', E100°58', 13.III.2002, 1 ♀ larva, coll. J. PETERS. – Thailand, Surrattani Prov., Amphur Phanom, Klong Bang Tan, N08°54', E98°35', 27.IV.2002, 1 ♀ larva, coll. J. PETERS. – Thailand, Chiang Mai Prov., creek, Chiang Dao National Park, Namtok Srisungwan, N19°37', E98°57', 17.III.2002, 1 ♀, coll. J. PETERS.

PCB 2.1, Thailand, Petchabun Prov., Huai Hin Lad, Nam Nao National Park, 04.VIII.1998, 2 larvae, leg. N. SANGPRADUB (as all following samples). – PCB 3.3, Thailand, Petchabun Prov., Phromlaeng, Nam Nao National Park, N16°38'24.02", E101°34'52.90", 9.IV.2013, 2 larvae. – PCB 5.1, Thailand, Petchabun Prov., Yakraue, Nam Nao National Park, N16°44'21.60", E101°34'28.84", 26.V.2012, 1 larva. – KKJ 1.3, Thailand, Kanchanaburi Prov., Pa La Au3, Kaeng Krachan National Park, 1.III.2008, 1 larva. – CYP 1.1, Thailand, Chaiyaphum Prov., Huai Tat Fah Noi, N16°27'24.50", E101°47'41.10", 28.III.2000, 2 larvae. – CYP 3.2, Thailand, Chaiyaphum Prov., Huai Tat Fah, Phu Khiao Wildlife Sanctuary, 07.V.1996, 3 larvae. – CYP 3.3, Thailand, Chaiyaphum Prov., Tat Fah Noi, Phu Khiao Wildlife Sanctuary, 28.III.2000, 1 larva. – SKK 2.2, Thailand, Sakon Nakhon Prov., Keng Mod Dang, Phu Phan National Park, 18.III.1989, 1 ♂. – LOI 1.1, Thailand, Loei Prov., Huai Wang Yow, N16°58'94.20", E101°46'60.50", 09.XI. 2002, 2 larvae. – MUN 1.3, Thailand, Buriram Prov., Ban Wang Krut, Mun River, N15°17'55.08", E103°17'18.88", 23.II.2003, 1 larva. – MUN 1.4, Thailand, Sisaket Prov., Ban Tha, Mun River, N15°18'15.60", E104°12'15.50",

24.II.2003, 1 larva. – SKP 1.1, Thailand, Nakhon Phanom Prov., Tat Kham Waterfall, N17°57'03.65", E104°09'13.30", 20.III.2012, 7 larvae. – SKP 1.2, same data, 1 larva. – SKP 2.1, Thailand, Nakhon Phanom Prov., Tat Pho Waterfall, N17°57'46.58", E104°08'24.39", 23.IX.2012, 1 larva. – POG 1.3, Thailand, Khon Kaen Prov., Ban Kut Numsainoi, Phong River, N16°43'45.79", E102°50'06.93", 27.II.1996, 2 larvae. – POG 1.6, Thailand, Loei Prov., Ban Si Than, Phong River, N16°50'44.62", E101°56'39.83", 27.II.1996, 1 larva. – POG 3.1, Thailand, Khon Kaen Prov., Ban Nong Tae, Phong River, N16°45'49.36", E102°40'04.14", 27.II.1996, 1 larva. – MRC 1.2, Thailand, Ubon Ratchantani Prov., Kong Chiam Distr., Mun River, 18.VI.2013, 1 larva.

Male imago

Measurements, ratios and colouration

Body length: 3.3 mm; wing length: 3.5 mm; length of fore leg: 2.5 mm. Ratio of fore femur : fore tibia = 0.63; ratio of fore tibia : fore tarsus = 1.00; ratio of fore leg : hind leg = 1.98; ratio of segments of the fore tarsus 1st : 2nd : 3rd : 4th : 5th = 1 : 2.4 : 2.2 : 2.4 : 2.7. – Colouration of cuticle: Mesonotum light yellowish-brown. Pronotum yellowish-white. Other parts white. – Epidermal pigmentation: Frons and vertex blackish-brown. Fore and hind margins of pronotum, margins of prealar and sutures of mesonotum brownish. Scutellum, median part of metanotum and abdominal terga shaded with brown, more intense on hind margins.

Morphology

Head: Base of antennal flagellum dilated. Dilated part about 0.8 times as long and 0.4 times as wide as pedicel. The latter elongated, about 2.5 times as long as wide. – **Thorax**: Fore coxae widely separated, prosternum weakly sclerotized, no ridge visible in lateral view. – **Abdomen**: Abdominal segment III with a very short rudimentary lateral process. Segment IV with a lateral process of moderate length, very long processes on segments V–VIII and a short one on segment IX. Tergum II with a very short and thin finger-like posteromedial process. – **Genitalia and sternum IX** as in Fig. 4a. Weakly sclerotized. Penis broadly rounded, with more or less developed posteromedial incision. Lateral sclerite brownish sclerotized, without ridge, anteriorly diverging. Forceps sickle-shaped, more or less evenly broadened to the base; narrowed apical part with a longitudinal ridge.

The herein described characters can also be observed in a couple of last instar male larvae (PCB 3.3, SKP 1.1, LOI 1.1), namely the male genitalia (Fig. 4d). A certain variability shows the shape of antennal base (Figs. 4c and h, subimaginal stage maybe not finally developed) and the shape of forcipes (compare Figs. 4b, e–g).

Female

The female could be assigned to the genus by its processes on abdominal segments III–IX and linked to the larva of *Tigrocercus dangi* by shape and structure of the eggs.

Measurements and colouration

Female, body length 4.5 mm, wing length 5.3 mm. – Colouration of cuticle: Mesonotum yellowish-brown, head, pronotum and metanotum light yellowish-brown, abdomen light brownish-yellow. – Epidermal pigmentation: blackish pigments concentrated on frons and vertex, margins and centre of pronotum, sutures of mesonotum, on scutellum, median parts of metanotum, pleura, base of wings and along subcosta and radius 1; abdominal terga blackish-grey, more intense on tergum 1 and 2.

Morphology

Body, particularly thorax, very broad. Distance from tip of wing to cross vein R1-R2 about 1.3 times of distance from cross vein R1-R2 to middle of costal brace. Fore coxae widely separated, prosternum broad, with a straight transverse ridge. Mesonotum anterior to mesonotal membrane not abruptly lowered. Posterior parapsidal suture anteriorly bowed medially. Scutellum broad. Metanotum without transverse ridge, hind margin with a very short, slightly bowed membrane. Abdominal segments IV–IX with long or very long lateral processes. Abdominal tergum II with a median finger-like process.

Egg

Eggs elongated, shaped like a fir cone (Fig. 22). With one short hose-shaped epithema, its end fingertip-shaped (Fig. 24). Chorion consisting of six longitudinal rows of scale-like structures. Lateroapical parts of each scale somewhat protruding, overlapping the laterobasal parts of scales of adjoining rows; each scale with central oval area of pores (Fig. 23). Micropyle not visible.

Larva

Measurements and colouration

Male larva, body length 4.0 mm, length of cerci 1.8 mm. Female larva, body length 5.0–6.0 mm, length of cerci 3.0–4.5 mm. – Colouration of cuticle brown. Spots on pro- and mesonotum, lateral parts of abdominal terga, dorsal side, legs and cerci pale yellowish-brown. Tibiae and tarsi often with transverse brown bands. – Epidermal pigmentation: a darker brown colouration often caused by diffuse grey pigments. Pigments often concentrated on the bases of the circular microtrichia (see below). Pronotum with two paramedian blackish spots. Greyish transverse bands on metanotum and abdominal terga. Gills 3–6 with strongly blackish bases, filaments less pigmented.

Morphology

Habitus see Fig. 13. – **Cuticle**: Dorsal side densely covered with circular microtrichia (Fig. 16), often more or less domed (Fig. 17a), sometimes funnel-shaped (Fig. 17b). Long thin bristles lateral and scattered on head and pronotum (Fig. 14). – **Head**: Ocelli

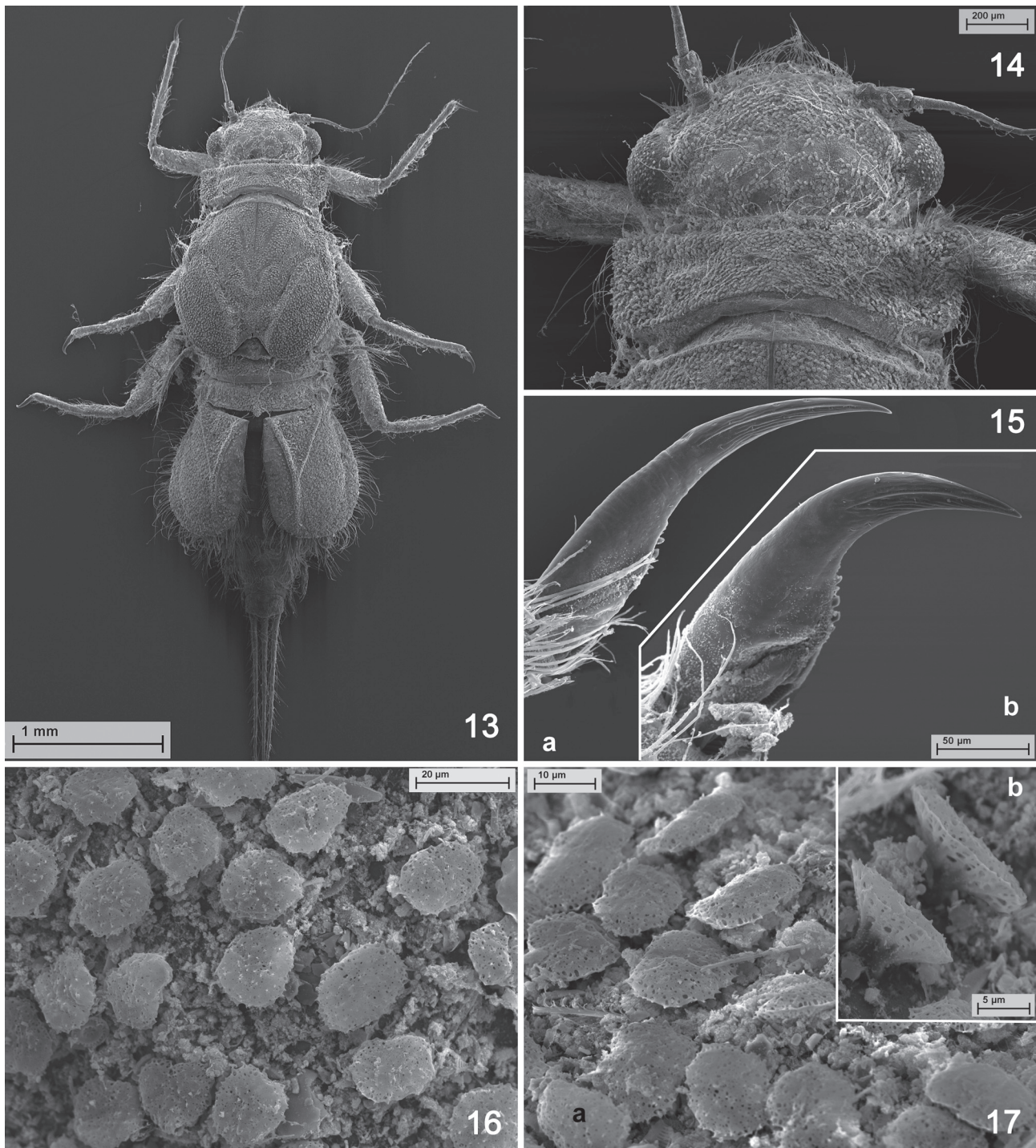

Figs. 13–17. *Tigrocercus dangi* n. comb., larva. – 13. Habitus. 14. Head and pronotum. 15. Fore claw (a) and mid claw (b). 16. Mesonotum, shield-shaped microtrichia. 17. Vertex, more or less domed microtrichia (a), pronotum, funnel-shaped microtrichia, lateral view (b).

scarcely domed. Clypeus densely provided with long bristles (Fig. 14). Genae not bulging out. Pedicel ventrally with 10–20 bristles of moderate length. No tree-shaped micro-

trichia between lateral ocelli. Mandibles with a dorsolateral field of thin bristles. Segments 2 and 3 of maxillary palp 1.3 times as long as labial palp segments 2 and 3. Seg-

ment 2 of labial palp about 1.7 times as long as segment 3. Surface of labium, particularly postmentum, with long bristles. – **T h o r a x**: Margins with very long thin bristles (Fig. 14). Pronotum 3.0–3.5 times as wide as length of lateral sides. Lateral margins straight, parallel or slightly diverging anteriorly (Fig. 3f). Basal two thirds of fore femur on dorsal side with longitudinally arranged thin bristles apically followed by a very irregular transverse row of about 6 stronger bristles. Coxal processes inconspicuous, narrow, sickle-shaped. Femora and tibiae marginally and dorsally with very long, hair-like bristles, a few bristles even on ventral side. Tarsi ventrally with a row of about 7 short and pointed bristles. Fore claws slender and slightly bowed (Fig. 15a), mid and hind claws apically bent (Fig. 15b), all claws basally with about 3–4 very small denticles. – **A b d o m e n**: Abdominal segments III–IX with lateral processes, IV–VIII long and bowed,

III and IX shorter (Fig. 3a). All processes with numerous long bristles, processes IV–VII with a dorsolateral row or group of pinnate bristles of moderate length (not on processes III, VIII and IX), not as broad and as strongly pinnate as in *Caenoculis* (Fig. 1s). Posteromedial process of tergum II cone-shaped and slightly bent posteriorly, with some circular microtrichia. Tergum I without posteromedial process. Hind margin of terga VII and VIII with very long, hair-like bristles, of tergum IX–X smooth (not denticulated as in most Caeninae). Hind margin of sternum IX broadly rounded (Fig. 3a), with long bristles, the median ones medially bent, some bristles also anterior to hind margin. Bristles not frayed. Gill I more than half as long as gill cover (Fig. 13). Operculate gill with long and very long bristles on lateral and hind margins, inner margin with shorter bristles (Fig. 19). Y-shaped ridges well developed, median ridge with a few long, thin bristles (Fig. 13).

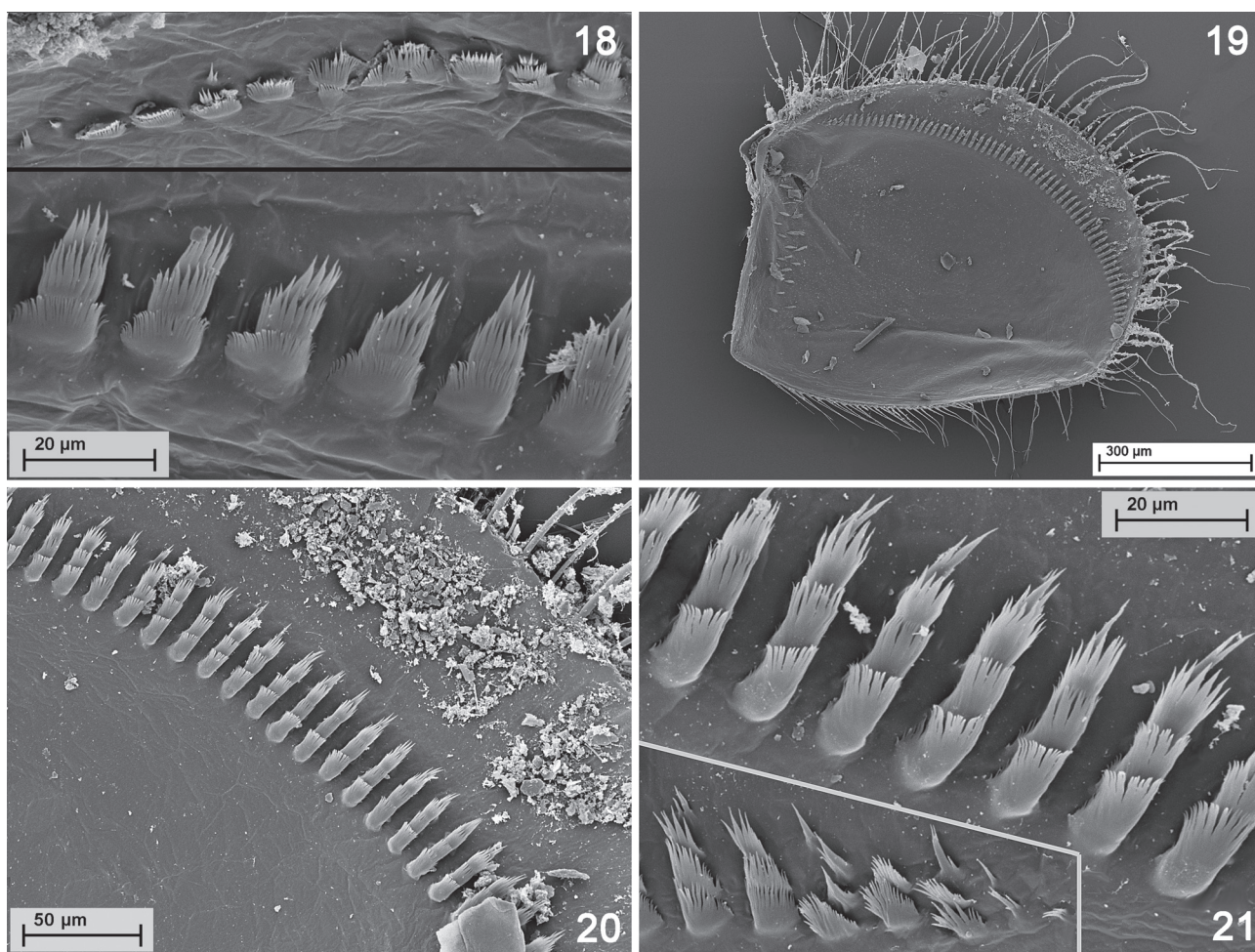

Figs. 18–21. *Tigrocercus* cf. *contractus* (18), *Tigrocercus dangi* n. comb. (19–21), larvae. – 18. Band of microtrichia from ventral side, sector from median part (below) and anterior end of the band (above). 19. Operculate gill, ventral view. 20. Operculate gill, band of microtrichia from ventral side. 21. Band of microtrichia from ventral side, sector from median part and anterior end of the band (small frame).

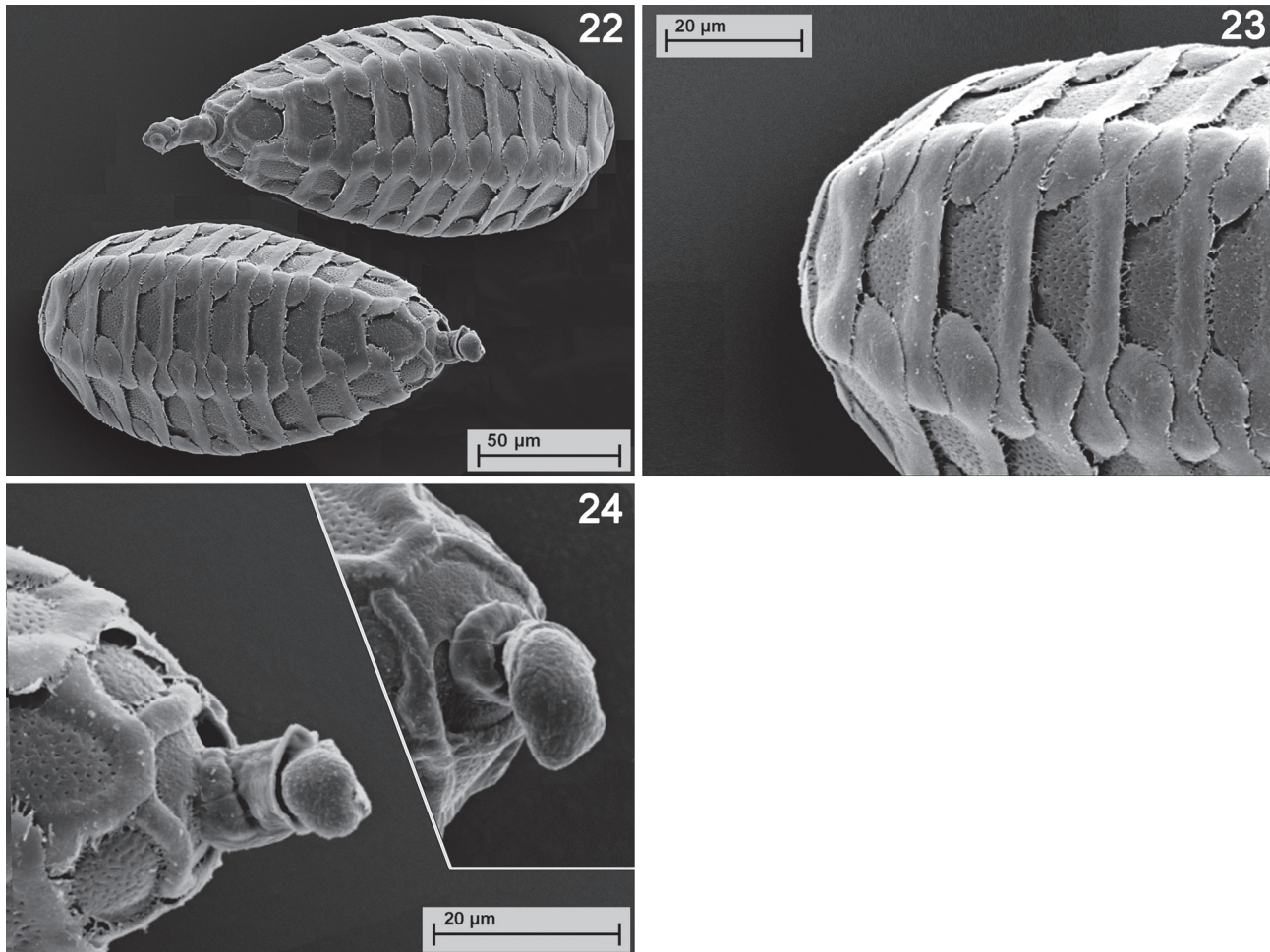

Figs. 22–24. *Tigrocercus dangi* n. comb., egg. – 22. Complete view. 23. Structure of chorion. 24. Epithema, two different shapes.

Band of microtrichia on ventral side of operculate gill running in a moderate distance to margin (Figs. 19, 20). It consists of transverse rows of 3–4 elongated microtrichia, rows 3–4 times as long as width of basal microtrichium (Figs. 20, 21). No pine needle shaped microtrichia. Most filaments of gills III(–V) with 3 or 4 branches.

Differential diagnosis

Tigrocercus dangi can be distinguished from *Tigrocercus* cf. *contractus*, the only other known larva of the genus, by following combination of characters: Lateral margins of pronotum straight, parallel or slightly converging anteriorly (Figs. 3f, 14). Hind margin of abdominal sternum IX broadly rounded (Fig. 3a), with long bristles, the median ones medially bent, some bristles present also distant from hind margin. Band of microtrichia on ventral side of operculate gill consists of transverse rows of 3–4 elongated microtrichia, rows 3–4 times as long as width of basal

microtrichium (Figs. 20, 21). Vertex without long bristles and tree-shaped microtrichia. Maxillary palp segments 2 and 3 1.3 times as long as labial palp segments 2 and 3.

Remarks

Within the Thailand material there are two larvae differing in a few characters from all the others. In view of the situation in the genus *Caenoculis* with its high variability and combinations of characters (see Discussion) I currently refrain from establishing new species and only describe the differing characters.

Sample POG 3.1, 1 ♀ larva. The specimen differs in the following characters: Because of a large number of very thin and irregularly bowed bristles the surface of the larva looks mouldy. Sides of pronotum concave, with angled fore corner and hind corner broadly rounded (Fig. 3g). Abdominal processes stronger bowed, they are more bent medially, particularly the posterior ones (Fig. 3b).

Sample MRC 1.2, 1 ♀ larva. The specimen differs in the following character: Cuticle with very long stalked tree shaped bristles (like those in Fig. 8), particularly a dense row on inner margin of wing buds.

3.3 Genus *Brachoculis* n. gen.

Type species: *Brachoculis acutalis* n. comb.

Etymology

The genus name is a combination of the syllables “Brach-” from Brachycercinae and “-oculis” from *Caenoculis*.

Diagnosis

Brachoculis can be characterised and distinguished from all other genera of Brachycercinae by the following combination of characters:

Larva: Habitus Brachycercini-like. Ocellar tubercles well developed, triangular, pointed. Maxillary and labial palps three-segmented. Mesonotum anterolaterally with two triangular pointed processes. Legs narrow and slender; fore legs shortened. Lateral processes on abdominal segments III–IX. Operculate gill with a band of scale-shaped microtrichia running immediately along lateral and hind margin of gill; microtrichia irregularly arranged. Sternite IX posteriorly protruding forming an isosceles triangle with slightly convex sides.

Male (subimaginal genitalia from last instar larva, ZHOU et al. 2003: figs. 40, 41): Styliiger plate protruding posteriorly, hind margin broadly rounded. Lateral sclerites posteriorly converging, without S-shaped keel. Basal part of forceps straight, more or less parallel-sided, apical third narrowed and bent medially, probably with a longitudinal ridge. Posterolateral corners of sternum IX with a very short, bump-like process.

For a detailed description of the species see ZHOU et al. (2003).

4 Discussion

In his description of *Caenoculis* from 1986, SOLDÁN mentioned the presence of long lateral processes on abdominal segments IV–VII in *Caenoculis bishopi* and IV–VIII in *Caenoculis nhahoensis*. My investigation of the type specimens of the latter species reveals that in all cases (four specimens) processes on segment VIII are lacking. Hence processes only on segments IV–VII can be supposed as a diagnostic character of the genus *Caenoculis*. The larvae from Java, coll. G. ULMER, also show this character and, together with short ocellar tubercles, it proves itself as *Caenoculis*. In last instar larvae with already visible early stage of subimago, it can be observed

Tab. 1. Differential-diagnostic characters of *Caenoculis* and *Tigrocercus*.

		<i>Caenoculis</i>	<i>Tigrocercus</i>
1	Male, fore tarsus	tarsomeres 3–5 subequal in length, 2 clearly longer than 3	tarsomeres 2–5 subequal in length
2	Male, outline of mesonotum	abruptly lowered anteriorly of mesonotal membrane	slightly lowered anteriorly of mesonotal membrane
3	Male, sternite 9	posterolateral corners rounded	posterolateral corners rounded, with processes of moderate length
4	Male, penis	ventrally with a median tongue-like structure often with 2 paramedian rounded processes	penis without those structures
5	Male, lateral sclerites	parallel, sclerotized, with S-shaped keel	anteriorly diverging, scarcely sclerotized, without S-shaped keel
6	Larva and imago, abdomen	lateral processes on segments 4–7	lateral processes on segments 3–9 (larva) or 4–9 (imago)
7	Larva, lateral ocelli	clearly domed	scarcely or not domed
8	Larva, pronotum	2.5–2.8 times as wide as length of lateral sides	3.0–3.5 times as wide as length of lateral sides
	Larva, posteromedial processes	on tergum I and II	on tergum II only
9	Larva, operculate gill	with posterolaterally protruding corner	posterolateral corner broadly rounded, not protruding
10	Larva, operculate gill, band of microtrichia	posterior part consisting of irregular transverse rows, peripherally dissolved	consisting of regular compact transverse rows, clearly separated from each other
11	Larva, operculate gill, ventral side	between band of microtrichia and lateral margin additionally with tongue or pine needle-shaped microtrichia	without those microtrichia
12	Larva, sternite 9	posteromedially protruding	posteromedially not protruding

that imagines possess the same number of lateral processes on the same segments as larvae do. The described male imagines from Thailand, coll. JAN PETERS, also show processes on segments IV–VII and therefore belong to *Caenoculis*. The so far unknown genitalia of *Caenoculis* are very similar to those of *Tigrocercus* Malzacher, 2006. Imagines of the latter genus however have long processes on abdominal segments IV–IX. The close relationship of the two genera is confirmed by the similarity of their genitalia. This allows for the conclusion that larvae which are very similar to those of *Caenoculis*, but with abdominal processes present on segments III–IX, in fact belong to the genus *Tigrocercus* (the very short process on segment III get nearly totally lost in the imagines). Therefore the larva from Nigeria very likely represents the West African species *Tigrocercus contractus* and that from Thailand another distinct *Tigrocercus* species. The examination of the holotype of *Caenoculis dangi* shows that this larva is identical with the *Tigrocercus* larvae from Thailand. So *Caenoculis dangi* has to be transferred to this genus as *Tigrocercus dangi* n. comb., a species that seems to be widely distributed in the Indochina region and that is now also known from a male (coll. N. SANGPRADUB, SKK 2.2).

A detailed examination of all available specimens yields a couple of additional differential-diagnostic characters listed in Tab. 1 and allows for their assignment to one of these two genera. On this basis *Tigrocercus nastassjae* Malzacher, 2013 has to be renamed as *Caenoculis nastassjae* (see characters 2–6 in Tab. 2).

As already mentioned above in the diagnosis of the genus *Caenoculis*, the high variability of larval diagnostic characters and their different combinations make it currently impossible to describe new *Caenoculis* species by use of larval characters. On the other hand, the few known males or last instar male larvae show differences in genital morphology e. g. penis and forceps shape. So the herein

described genitalia (Figs. 2a, b) and those of *Caenoculis nastassjae* (MALZACHER 2013: figs. 10a, b) unquestionably each represent different species. Also the differing forceps shape of the specimens from Java (Fig. 2f) and the Thailand specimen SKP 2.1 (Fig. 2d) could give rise to the presumption of different species. However a subdivision of the genus in well defined species will only be possible with the knowledge of a representative number of males from different regions and their assignment to the larvae.

While KLUGE (2004) regarded *Caenoculis* as incertae sedis and did not assign it to a higher taxon, SUN & McCAFFERTY (2008) placed the genus in the Brachycercinae as an own tribe, particularly because of the presence of ocellar tubercles. Besides this, *Caenoculis* shows the plesiomorphic characters of three-segmented maxillary and labial palps. This combination of characters induced ZHOU et al. (2003) to describe a new species from China as *Caenoculis acutalis*. The habitus of this species however is very similar to that of the remaining Brachycercinae (Fig. 25), including two of their synapomorphies: (1) ocellar tubercles well developed, triangular and pointed (definitely distinguishable from the clearly weaker developed tubercles in *Caenoculis*); (2) legs narrow and slender, fore legs shortened. On the other hand, *Caenoculis* and *Tigrocercus* share two synapomorphies that cannot be found in *Caenoculis acutalis*: (3) band of microtrichia on ventral side of operculate gill consisting of transverse rows, and (4) cuticle densely covered with shield-shaped microtrichia. Based on this distribution of characters, not only the establishing of a separate genus, *Brachoculis*, seems to be justified (all differential diagnostic characters in Tab. 2), but also its transfer within the remaining tribes of Brachycercinae. Within this group, *Brachoculis* shows the apomorphic character (5) operculate gill with a broad marginal band of irregularly arranged scale like microtrichia. This type of microtrichia band is unique within

Tab. 2. Differential-diagnostic characters of *Caenoculis* and *Brachoculis*.

		<i>Caenoculis</i>	<i>Brachoculis</i>
1	Larva, habitus	<i>Caenis</i> -like	<i>Brachycercus</i> -like
2	Larva, cuticle	densely covered with shield-shaped microtrichia	without shield-shaped microtrichia
3	Larva, sides of pronotum	parallel	anteriorly converging
4	Larva, mesonotum	anterolaterally without process	with an anterolateral triangular process
5	Larva, legs/fore leg	not slender/not shortened (<i>Caenis</i> -like)	narrow and slender/shortened (<i>Brachycercini</i> -like)
6	Larva, abdomen	lateral processes on segments 4–7	lateral processes on segments 3–9
7	Larva, ocellar tubercles	short, more or less rounded	well developed, triangular, pointed
8	Larva, gill II, ventral band of microtrichia	far away from lateral and hind margin	immediately along lateral and hind margin
9	Larva, gill II, ventral band of microtrichia	consisting of transverse rows	no transverse rows, microtrichia irregularly arranged

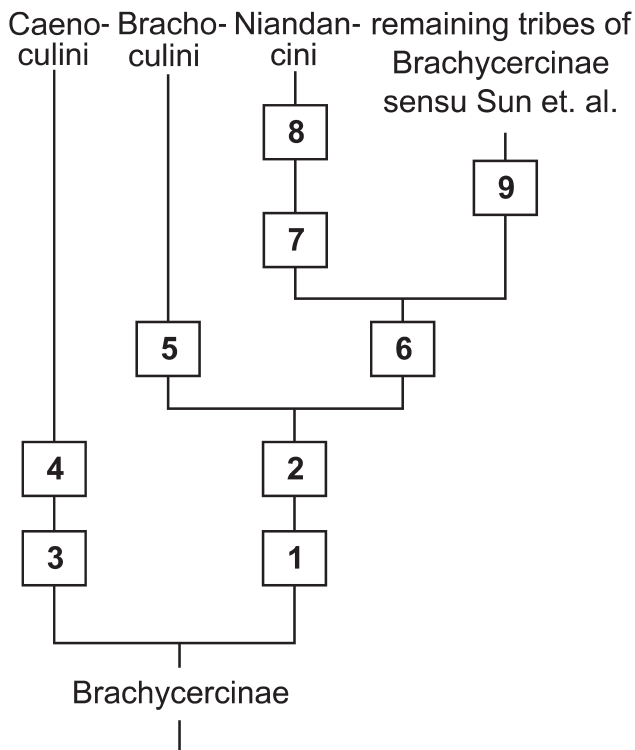

Fig. 25. Tree of Brachycercinae tribes. – For explanation see Discussion.

Caenidae. All other Brachycercinae share the synapomorphy (6) maxillary and labial palps two-segmented. Hence *Brachoculis* can be regarded as sister to the latter and can be classified as a tribe for its own: Brachoculini.

The Brachycercinae with two-segmented palps for their part can be subdivided into sister groups: 1. The tribe Niandancini (n. trib.) with the species *Niandancus*

alienus Malzacher, 2009 shows two apomorphies: (7) mid and hind coxae with long pointed processes (MALZACHER 2009: figs. 11e, f), and (8) mouthparts shifted posteriorly (MALZACHER 2009: fig. 11a). 2. The remaining tribes of Brachycercinae sensu SUN & McCAFFERTY 2008 share the synapomorphy: (9) lateral spines of abdomen bent dorsally, forming a gill basket.

5 References

- KLUGE, N. YU. (2004): The phylogenetic system of Ephemeroptera, 442 pp.; Dordrecht/Boston/London (Kluwer Academic Publishers).
- MALZACHER, P. (2009): Two new genera of Caenidae (Insecta: Ephemeroptera) from West Africa. – *Aquatic Insects* **31**: 279–292.
- MALZACHER, P. (2013): Caenidae from East Kalimantan, Borneo (Insecta: Ephemeroptera). With a discussion on phylogeny of the new tribe Clypeocaenini, subfamily Caeninae. – *Stuttgarter Beiträge zur Naturkunde A, Neue Serie* **6**: 21–55.
- MALZACHER, P. (2015): The Caenidae in the collection ULMER, Hamburg (Insecta: Ephemeroptera). – *Entomologische Mitteilungen des Zoologischen Museums Hamburg* **17**(194): 201–205.
- MALZACHER, P. & STANICZEK, A. H. (2006): Revision of the Madeocercinae (Ephemeroptera Caenidae). – *Aquatic Insects* **28**: 165–193.
- McCAFFERTY, W. P. & WANG, T.-Q. (2000): Phylogenetic systematics of the major lineages of pannota mayflies (Ephemeroptera: Pannota). – *Transactions of the American Entomological Society* **126**: 9–121.
- SOLDÁN, T. (1986): A revision of the Caenidae with ocellar tubercles in the nymphal stage (Ephemeroptera). – *Acta Universitatis Carolinae, Biologica* **1982–1984**: 289–362.
- SUN, L. & McCAFFERTY, W. P. (2008): Cladistics, classification and identification of the brachycercine mayflies (Insecta: Ephemeroptera: Caenidae). – *Zootaxa* **1801**: 1–239.
- ZHOU, C., SUN, L. & McCAFFERTY, W. P. (2003): A new species of *Caenoculis* Soldán from China (Ephemeroptera: Caenidae). – *The Pan-Pacific Entomologist* **79**: 185–191.

Authors' addresses:

Dr. PETER MALZACHER, Friedrich-Ebert-Straße 63, 71638 Ludwigsburg, Germany;
e-mail: malzacher.lb@t-online.de

Dr. NARUMON SANGPRADUB, Applied Taxonomic Research Center, Department of Biology, Faculty of Science, Khon Kaen, University, Thailand;
e-mail: narumon@kku.ac.th

Manuscript received: 27.V.2016, accepted: 22.VII.2016.