



---

## **Phylogeography, Species Limits, Phylogeny, and Classification of the Turacos (Aves: Musophagidae) Based on Mitochondrial and Nuclear DNA Sequences**

Authors: Perктаş, Utku, Groth, Jeff G., and Barrowclough, George F.

Source: American Museum Novitates, 2020(3949) : 1-61

Published By: American Museum of Natural History

URL: <https://doi.org/10.1206/3949.1>

---

BioOne Complete (complete.BioOne.org) is a full-text database of 200 subscribed and open-access titles in the biological, ecological, and environmental sciences published by nonprofit societies, associations, museums, institutions, and presses.

## Phylogeography, Species Limits, Phylogeny, and Classification of the Turacos (Aves: Musophagidae) Based on Mitochondrial and Nuclear DNA Sequences

UTKU PERKTAŞ,<sup>1,2</sup> JEFF G. GROTH,<sup>1</sup> AND GEORGE F. BARROWCLOUGH<sup>1</sup>

### ABSTRACT

We used mitochondrial and nuclear DNA sequences to examine patterns of differentiation and evolution in the Musophagidae, an avian family endemic to sub-Saharan Africa; attention was focused on the subfamily Musophaginae, the turacos, or louries. Phylogeographic analysis of 410 individual ND2 sequences from throughout the ranges of the currently recognized species revealed multiple instances of unexpectedly large genetic divergences and cryptic taxa. Within both montane and lowland species, including *Tauraco hartlaubi* and *T. schalowi*, *Menelikornis leucotis*, *Musophaga macrorhyncha*, and *Gallirex johnstoni*, fixed private haplotypes were found in disjunct portions of the ranges, suggesting negligible recent gene flow and evolutionary independence of populations. Two taxa originally described as subspecies (*T. schalowi loitanus* and *T. s. marungensis*), but not recognized for over 50 years, were found to be 100% diagnosable based on the mitochondrial sequences. The data also revealed the existence of two polyphyletic traditional species, *Tauraco livingstonii* and *T. schuettii*, as well as the polyphyly or paraphyly of all traditional superspecies complexes involving members of the genus *Tauraco*. Overall, our analyses of genetic and morphological variation revealed substantial and unexpected geographic diversity within the Musophagidae. We recognize 33 species-level taxa that represent the appropriate units for phylogenetic and biogeographic analyses (phylogenetic species).

We used complete mitochondrial ND2 sequences and nuclear DNA sequences of an Aconitase intron and of the RAG-1 exon to infer the phylogenetic relationships among those species. The results include all the phylogenetic species and, for the first time, nuclear data. We present

<sup>1</sup> Division of Vertebrate Zoology (Ornithology), American Museum of Natural History.

<sup>2</sup> Department of Biology (Zoology Section), Faculty of Science, Hacettepe University, Ankara.

a new classification of the Musophagidae based on our phylogeographic and phylogenetic results. We allocate the 33 species to seven previously recognized genera, an average of 4.7 species per genus.

## INTRODUCTION

The turacos and go-away-birds (Musophagidae) are a charismatic family of colorful birds now endemic to sub-Saharan Africa. A fossil from Wyoming placed as a sister to the crown clade suggests ancestral taxa were once more widely distributed (Field and Hsiang, 2018). The extant species are distributed throughout forest, bush, and savannah habitats (Chapin, 1963; Forshaw and Cooper, 2002), and occur from sea level to over 3000 m in elevation. Usually treated as three subfamilies, both their higher-level relationships and species limits have long been controversial. Sibley and Ahlquist (1990) reviewed the history of opinion on affinities of the musophagids with other family-level taxa; they had often been associated with cuckoos, based on their foot arrangement, but at various times had also been thought to be allied with the hoatzin (*Opisthocomus*) or with gallinaceous birds. Their relationships remain unresolved. Nuclear DNA sequences have suggested a sister-group relationship between turacos and a large clade of water birds (Hackett et al., 2008), bustards (Jarvis et al., 2014), or cuckoos plus bustards (Prum et al., 2015); Prum et al. (2015) suggested they have evolved separately from other avian lineages for 50–60 million years.

The taxonomies of two of the three subfamilies have generally been stable. One of these, the Corythaeolinae, is monotypic and comprised of the great blue turaco, *Corythaeola cristata*. A second subfamily, Criniferinae, comprises the mostly gray or brown go-away-birds; five generally recognized species possess largely allopatric ranges, although in some cases their ranges overlap with segregation by habitat (Snow, 1978).

The largest subfamily, the Musophaginae, consists of green or violet birds possessing unique, copper-based pigments (turacin and turacoverdin) in their plumage. The nomenclature, number, and composition of species in this group have long been problematic (table 1). Peters (1940) recognized 15 species (plus 18 additional subspecies) in four genera, but seven years later von Boetticher (1947) listed 17 species in 13 genera and subgenera. The most comprehensive analysis in recent times was that of Moreau (1958a, 1958b, 1958c) who recognized only 12 species in two genera. Subsequently, Snow (1978) recognized 16 species, Brosset and Fry (1988) recognized 14 species and, most recently, Turner (1997) and Dickinson and Remsen (2013) both recognized 17 species. However, these numbers obscure additional complexity: von Boetticher's (1947) 17 species are not identical to those of Dickinson and Remsen (2013).

Geographic variation in plumage and morphology of all the described taxa in this family was thoroughly described by Moreau (1958b). In addition to discrete differences, he also found cases of disagreement among characters and apparent clinal variation. He chose not to recognize some forms and combined others into species and superspecies based on a heuristic application of the biological species concept. Almost all the variation in recent species-level classifications of the birds have been based on differing interpretations of his characters in nonphylogenetic frame-

TABLE 1. Recent history of species-level taxonomy of Musophaginae.

Taxon	Peters (1940)	von Boetticher (1947)	Moreau (1958a)	Brosset and Fry (1988)	Forshaw and Cooper (2002)	Dickinson and Remsen (2013)	Treatment here
<i>porphyreolophus</i>	<i>Gallirex p. porphyreolophus</i>	<i>Gallirex p. porphyreolophus</i>	<i>Tauraco p. porphyreolophus</i>	<i>Musophaga p. porphyreolophus</i>	<i>Gallirex p. porphyreolophus</i>	<i>Gallirex p. porphyreolophus</i>	<i>Gallirex porphyreolophus</i>
<i>chlorochlamys</i>	<i>Gallirex porphyreolophus chlorochlamys</i>	<i>Gallirex porphyreolophus chlorochlamys</i>	<i>Tauraco porphyreolophus chlorochlamys</i>	<i>Musophaga porphyreolophus chlorochlamys</i>	<i>Gallirex porphyreolophus chlorochlamys</i>	<i>Gallirex porphyreolophus chlorochlamys</i>	<i>Gallirex chlorochlamys</i>
<i>johnstoni</i>	<i>Ruwenzorornis j. johnstoni</i>	<i>Ruwenzorornis j. johnstoni</i>	<i>Tauraco j. johnstoni</i>	<i>Musophaga j. johnstoni</i>	<i>Gallirex j. johnstoni</i>	<i>Gallirex j. johnstoni</i>	<i>Gallirex johnstoni</i>
<i>kivuensis</i>	<i>Ruwenzorornis johnstoni kivuensis</i>	<i>Ruwenzorornis johnstoni kivuensis</i>	<i>Tauraco johnstoni kivuensis</i>	<i>Musophaga johnstoni kivuensis</i>	<i>Gallirex johnstoni kivuensis</i>	<i>Gallirex johnstoni kivuensis</i>	<i>Gallirex kivuensis</i>
<i>leucotis</i>	<i>Tauraco l. leucotis</i>	<i>Tauraco (Menelikornis) l. leucotis</i>	<i>Tauraco l. leucotis</i>	<i>Tauraco l. leucotis</i>	<i>Tauraco l. leucotis</i>	<i>Tauraco l. leucotis</i>	<i>Menelikornis leucotis</i>
<i>donaldsoni</i>	<i>Tauraco leucotis donaldsoni</i>	<i>Touraco (Menelikornis) l. donaldsoni</i>	<i>Tauraco leucotis donaldsoni</i>	<i>Tauraco leucotis donaldsoni</i>	<i>Tauraco leucotis donaldsoni</i>	<i>Tauraco leucotis donaldsoni</i>	<i>Menelikornis donaldsoni</i>
<i>ruspolii</i>	<i>Tauraco ruspolii</i>	<i>Touraco (Menelikornis) ruspolii</i>	<i>Tauraco ruspolii</i>	<i>Tauraco ruspolii</i>	<i>Tauraco ruspolii</i>	<i>Tauraco ruspolii</i>	<i>Menelikornis ruspolii</i>
<i>rossae</i>	<i>Musophaga violacea rossae</i>	<i>Musophaga violacea rossae</i>	<i>Musophaga rossae</i>	<i>Musophaga rossae</i>	<i>Tauraco rossae</i>	<i>Tauraco rossae</i>	<i>Musophaga rossae</i>
<i>violacea</i>	<i>Musophaga v. violacea</i>	<i>Musophaga v. violacea</i>	<i>Musophaga violacea</i>	<i>Musophaga violacea</i>	<i>Tauraco violaceus</i>	<i>Tauraco violaceus</i>	<i>Musophaga violacea</i>
<i>macrothylncha</i>	<i>Tauraco m. macrothylnchus</i>	<i>Touraco (Pseudopoëtus) m. macrothylnchus</i>	<i>Tauraco m. macrothylnchus</i>	<i>Tauraco m. macrothylnchus</i>	<i>Tauraco m. macrothylnchus</i>	<i>Tauraco m. macrothylnchus</i>	<i>Musophaga macrothylncha</i>
<i>verreauxii</i>	<i>Tauraco macrothylnchus verreauxii</i>	<i>Touraco (Pseudopoëtus) macrothylnchus verreauxii</i>	<i>Tauraco macrothylnchus verreauxii</i>	<i>Tauraco macrothylnchus verreauxii</i>	<i>Tauraco macrothylnchus verreauxii</i>	<i>Tauraco macrothylnchus verreauxii</i>	<i>Musophaga verreauxii</i>
<i>bannermani</i>	<i>Tauraco bannermani</i>	<i>Proturacus bannermani</i>	<i>Tauraco bannermani</i>	<i>Tauraco bannermani</i>	<i>Tauraco bannermani</i>	<i>Tauraco bannermani</i>	<i>Proturacus bannermani</i>

TABLE 1 continued

Taxon	Peters (1940)	von Boetticher (1947)	Moreau (1958a)	Brosset and Fry (1988)	Forshaw and Cooper (2002)	Dickinson and Remsen (2013)	Treatment here
<i>leucolophus</i>	<i>Tauraco leucolophus</i>	<i>Heuglinornis leucolophus</i>	<i>Tauraco leucolophus</i>	<i>Tauraco leucolophus</i>	<i>Tauraco leucolophus</i>	<i>Tauraco leucolophus</i>	<i>Proturacus leucolophus</i>
<i>erythrolophus</i>	<i>Tauraco erythrolophus</i>	<i>Tauraco (Proturacopsis) erythrolophus</i>	<i>Tauraco erythrolophus</i>	<i>Tauraco erythrolophus</i>	<i>Tauraco erythrolophus</i>	<i>Tauraco erythrolophus</i>	<i>Proturacus erythrolophus</i>
<i>persa</i>	<i>Tauraco p. persa</i>	<i>Touraco (Touraco) p. persa</i>	<i>Tauraco corythaix persa</i>	<i>Tauraco p. persa</i>	<i>Tauraco p. persa</i>	<i>Tauraco p. persa</i>	<i>Tauraco persa</i>
<i>buffoni</i>	<i>Tauraco persa buffoni</i>	<i>Touraco (Touraco) persa buffoni</i>	<i>Tauraco corythaix buffoni</i>	<i>Tauraco persa buffoni</i>	<i>Tauraco persa buffoni</i>	<i>Tauraco persa buffoni</i>	<i>Tauraco buffoni</i>
<i>emini</i>	<i>Tauraco schuettii emini</i>	<i>Touraco (Spelectoides) schuetti</i> [sic] <i>emini</i>	<i>Tauraco corythaix emini</i>	<i>Tauraco schuettii emini</i>	<i>Tauraco schuettii emini</i>	<i>Tauraco schuettii emini</i>	<i>Tauraco emini</i>
<i>hartlaubi</i>	<i>Tauraco hartlaubi</i>	<i>Touraco (Pseudogallirex) hartlaubi</i>	<i>Tauraco hartlaubi</i>	<i>Tauraco hartlaubi</i>	<i>Tauraco hartlaubi</i>	<i>Tauraco hartlaubi</i>	<i>Tauraco hartlaubi</i>
<i>fischeri</i>	<i>Tauraco fischeri</i>	<i>Touraco (Proturacopsis) fischeri</i>	<i>Tauraco corythaix fischeri</i>	<i>Tauraco fischeri</i>	<i>Tauraco fischeri</i>	<i>Tauraco fischeri</i>	<i>Tauraco fischeri</i>
<i>reichenowi</i>	= <i>Tauraco livingstonii cabanisi</i>	<i>Touraco (Neumannornis) reichenowi</i>	= <i>Tauraco corythaix livingstonii</i>	= <i>Tauraco persa livingstonii</i>	<i>Tauraco livingstonii reichenowi</i>	<i>Tauraco livingstonii reichenowi</i>	<i>Tauraco reichenowi</i>
<i>corythaix</i>	<i>Tauraco corythaix</i>	<i>Touraco (Opoëthus) corythaix</i>	<i>Tauraco c. corythaix</i>	<i>Tauraco persa corythaix</i>	<i>Tauraco corythaix</i>	<i>Tauraco corythaix</i>	<i>Tauraco corythaix</i>
<i>livingstonii</i>	<i>Tauraco l. livingstonii</i>	<i>Touraco (Neumannornis) livingstonii</i>	<i>Tauraco corythaix livingstonii</i>	<i>Tauraco persa livingstonii</i>	<i>Tauraco l. livingstonii</i>	<i>Tauraco l. livingstonii</i>	<i>Tauraco livingstonii</i>
<i>schuettii</i>	<i>Tauraco s. schuettii</i>	<i>Touraco (Spelectoides) s. schuetti</i> [sic]	<i>Tauraco corythaix schuettii</i>	<i>Tauraco s. schuettii</i>	<i>Tauraco s. schuettii</i>	<i>Tauraco s. schuettii</i>	<i>Tauraco schuettii</i>
<i>chalcolophus</i>	<i>Tauraco livingstonii chalcolophus</i>	<i>Touraco (Neumannornis) schalowi chalcolophus</i>	<i>Tauraco corythaix chalcolophus</i>	<i>Tauraco persa chalcolophus</i>	<i>Tauraco schalowi chalcolophus</i>	= <i>Tauraco schalowi chalcolophus</i>	<i>Tauraco chalcolophus</i>

TABLE 1 continued

Taxon	Peters (1940)	von Boetticher (1947)	Moreau (1958a)	Brosset and Fry (1988)	Forsshaw and Cooper (2002)	Dickinson and Remsen (2013)	Treatment here
<i>schalowi</i>	<i>Tauraco livingstonii schalowi</i>	<i>Touraco (Neumannornis) s. schalowi</i>	<i>Tauraco corythaix schalowi</i>	<i>Tauraco persa schalowi</i>	<i>Tauraco s. schalowi</i>	<i>Tauraco schalowi</i>	<i>Tauraco schalowi</i>
<i>loitanus</i>	<i>Tauraco livingstonii loitanus</i>	<i>Touraco (Neumannornis) schalowi loitanus</i>	= <i>Tauraco corythaix schalowi</i>	= <i>Tauraco persa schalowi</i>	= <i>Tauraco s. schalowi</i>	= <i>Tauraco schalowi</i>	<i>Tauraco loitanus</i>
<i>marungensis</i>	<i>Tauraco livingstonii marungensis</i>	<i>Touraco (Neumannornis) schalowi marungensis</i>	= <i>Tauraco corythaix schalowi</i>	= <i>Tauraco persa schalowi</i>	= <i>Tauraco s. schalowi</i>	= <i>Tauraco schalowi</i>	<i>Tauraco marungensis</i>

works. The general problem has been that many of these birds are quite similar in appearance and it has been difficult to place species limits on the parapatric, geographically replacing forms that possess subtle differences or conflicting patterns of phenotypic traits. A second complication arising in these birds is the historic association, among avian taxonomists, of particular anatomical characters with rank (Mayr, 1982); for example, nostril shape was often considered a generic character, while bill color was usually treated as a species- or subspecies-level trait; crest length might be a subspecific or clinal trait (e.g., Moreau, 1959). Thus, for many taxonomists, the green turacos of the Congo Basin possessing black bills had to be related, even if aspects of their plumage suggested otherwise. These various issues have resulted in idiosyncratic and conflicting classifications that need to be resolved; species limits are a serious concern because studies of evolutionary diversification and historical biogeography require monophyletic species taxa as the basic units of analysis (Barrowclough et al., 2016).

We investigated geographic variation, species limits, and phylogeny of the Musophagidae using mitochondrial and nuclear DNA sequences to resolve turaco systematics. Phylogeography has frequently been useful for identifying cryptic evolutionary units and determining species limits in difficult groups of birds, including those in Africa. For example, African chats (*Cercomela*: Outlaw et al., 2010), bush-shrikes (*Laniarius*: Voelker et al., 2010a), and cisticoline warblers (*Scepomycter*: Bowie et al., 2009) all represent difficult taxa in which molecular studies of geographic variation have been highly informative. Although the phylogenetic relationships among turacos have recently been investigated using both morphology (Veron, 1999) and molecules (Veron and Winney, 2000; Njabo and Sorenson, 2009), these studies were all restricted to exemplars of the generally recognized taxa, accepting traditional classifications based on the biological species concept and either postulated hybrid zones or an inferred ability to hybridize. The monophyly of those biological species was assumed, but not assessed.

For the most part, turacos have large, often parapatric ranges. Consequently, they provide important data concerning large-scale patterns of African biogeography and associated historical processes (Dowsett-Lemaire and Dowsett, 2001). Indeed, these birds have figured in several attempts to assay general patterns of distribution and endemism (e.g., Crowe and Crowe, 1982) with subsequent linkage to Quaternary climate change (Livingstone, 1975). They also have figured in arguments concerning the efficacy of Pleistocene refuge models of speciation (Mayr and O'Hara, 1986), and the role of ecological isolation in species' distributions (e.g., Lack, 1971). An improved knowledge of turaco diversification should benefit such investigations.

## MATERIALS AND METHODS

### NOMENCLATURE

The results we report here for the Musophaginae require a species-level classification incompatible with all prior treatments; some names we recognize have not been used in more than 75 years. Consequently, it is difficult to discuss parts of our results using the most recent classification of turacos (Dickinson and Remsen, 2013). In some cases, we use specific epithets in the following text, tables, and figures that may not be widely recognized. In table 1 we pro-

vide a brief synopsis of recent species-level classifications of this subfamily, relevant synonymies, and the species level taxonomy supported by our data.

#### SAMPLES

We obtained preserved tissue samples of turacos from the American Museum of Natural History, the Field Museum of Natural History, the Peabody Museum of Natural History at Yale University, the Burke Museum of the University of Washington, the Zoological Museum of the University of Copenhagen, and the British Museum (Natural History) at Tring. However, a relatively small number of geographically dispersed samples were available for most of the generally recognized species-level taxa and, in the case of *ruspolii*, none were available. Consequently, we relied on toe pads of traditional museum specimens for the vast majority of our geographic sampling for DNA sequencing. In addition, we examined traditional museum skins in the collections of the American Museum of Natural History and the Field Museum of Natural History to confirm plumage and soft-part differences among the recognized forms that had been previously described and illustrated by Moreau (1958b) and Forshaw and Cooper (2002).

#### LABORATORY METHODS

We extracted DNA from the tissue and toe pad samples using standard procedures previously described (e.g., Barrowclough et al., 2011). We sequenced approximately one half of the mitochondrial ND2 gene from the specimens available as toe pad samples. These samples were, in some cases, over 100 years old; consequently, a set of turaco specific PCR primers was designed to amplify 100 to 200 base pair (bp) fragments for those specimens for which longer fragments could not readily be amplified. ND2 extraction and sequencing from large numbers of traditional skin preparations previously has been shown to provide useful data for avian phylogeography (e.g., Reddy, 2008; Perктаş et al., 2011). In addition, we amplified the entire ND2 gene for single exemplars of each of the generally recognized species of musophagids, as well as of subspecific taxa that we found to be genetically divergent in our analyses. Each of these exemplars was also sequenced for the entire 15th intron of the nuclear aconitase-1 gene, using methods previously described (Barrowclough et al., 2011). Finally, we amplified and sequenced a large portion of the nuclear RAG-1 gene for those taxa of turacos for which preserved tissue samples were available, again using previously described procedures (Groth and Barrowclough, 1999). All the PCR products were Sanger sequenced and the chromatograms recorded on an ABI 3730xl DNA analyzer.

#### ANALYSES

The DNA sequences were assembled, aligned, and analyzed using Sequencher software (version 5.1). We used the program PAUP\* version 4.0b10 (Swofford, 2001) to infer minimum-length networks for both the entire set of partial ND2 sequences and for the reduced



set of unique haplotypes found among those sequences. For each of the three exemplar data sets of differentiated taxa (complete ND2, ACO1-I15, and RAG-1), we checked for unusual nucleotides, excessive proportions of ambiguity codes, heterogeneity of base composition at all three coding positions, signatures of contamination (chimerism) and, for the two protein-coding genes, unexpected stop codons and indels not a multiple of three bp in length. We used PAUP\* to infer most parsimonious trees for the data sets using 25 TBR heuristic searches (random stepwise addition of taxa, gaps treated as missing, and ambiguities treated as uninformative). We also performed a bootstrap analysis of the parsimony procedure with 100 replicates.

We used the program MODELTEST version 3.06 (Posada and Crandall, 1998) to find initial maximum likelihood models for the three exemplar data sets using the AIC criterion. We then followed the protocol suggested by Sullivan et al. (2005) and performed initial maximum likelihood heuristic TBR searches, using PAUP\*, with fixed parameters from the model specified by MODELTEST, starting at the maximum parsimony tree. Upon completion of the likelihood search, we reestimated the likelihood model parameters on the resulting tree; if the parameters had changed, we fixed the new parameters and started a subsequent TBR search. We repeated this procedure until the resulting likelihood tree was consistent with its initial parameters. Finally, we performed likelihood bootstrap analyses using the fixed final parameter sets with 100 TBR replicates, starting from trees obtained using neighbor-joining.

We examined base composition variation among taxa for all three loci. Base composition heterogeneity in vertebrate nuclear genomes is frequently characterized by variation in C plus G content. For the nuclear, noncoding aconitase intron, we computed the overall C plus G fraction for each of the members of the Musophaginae, the Criniferinae, *Corythaeola*, and the four outgroups (see below). For the coding RAG-1 nuclear gene, we computed the overall C plus G fraction for third position synonymous sites and for first plus second position amino-acid replacement sites. In the vertebrate mitochondrial genome, transitions greatly outnumber transversions; consequently, the A plus G fraction is nearly independent of the C plus T fraction for closely related taxa. Therefore, we computed the A and C fractions at third codon positions for the mitochondrial ND2 locus (e.g., Groth et al., 2015).

We used the program GARLI version 2.01 (Zwickl, 2006) to obtain an overall estimate of turaco phylogeny across loci. Each of the three genes was treated as a separate partition in this likelihood analysis, with its own model parameters optimized during the search, using the autostopping criterion. A bootstrap analysis was performed with 100 replicates and five stepwise random addition searches within each replicate.

In all our phylogenetic analyses, we used a bustard, crane, cuckoo, and stork as outgroups based on recent opinions concerning the phylogenetic relatives of turacos. For our ND2 analyses, we used four sequences from GenBank for that purpose: *Otis tarda*: NC014046; *Antigone canadensis*: FJ769855; *Coccyzus americanus*: EU327609; and *Ciconia ciconia*: NC002197. For ACO1, we sequenced the same four species ourselves. For RAG-1, we used two outgroup sequences from GenBank (*A. canadensis*: AF143732 and *C. americanus*: DQ482640) and sequenced the other two.

Within each species or traditional species complex, we grouped individuals into populations composed of samples taken from collecting localities within the same small country or small region for larger political entities. For those populations with sample sizes of three or more, we estimated Nei's (1987) nucleotide diversity ( $\pi$ ) and computed Holsinger and Mason-Gamer's (1996)  $G_{st}$  statistic. The latter is an estimator of the ratio between the among-population and total coalescent times (Slatkin, 1991).

We used the program ARLEQUIN version 3.5.2.2 (Excoffier et al., 2005) to estimate hierarchical components of genetic variance between previously recognized subspecies for those cases in which we observed substantial divergence in the ND2 phylogeographic analysis. In these estimates, transitions and transversions were equally weighted; the levels of analysis were: among subspecies; among populations within subspecies; and within populations. The estimate of  $F_{st}$  among subspecies was taken as the hierarchical component of genetic variance among those taxa.

## RESULTS

### PHYLOGEOGRAPHY

We obtained an aligned set of 410 partial sequences of the ND2 gene from representatives of all generally recognized species, and most subspecies, of musophagine turacos. The partial ND2 data set was 607 bp long and corresponded to base pairs 5405 through 6011 of the published complete mitochondrial genome of *Gallus* (Desjardins and Morais, 1990). No indels or ambiguous bases were required in the alignment. These sequences have been deposited in GenBank; GenBank accession number, museum voucher information, as well as available data on the geographic origin of each specimen are provided in appendix 1. Unfortunately, many of these specimens were very old and the correspondence between their label data and currently recognized place names was sometimes difficult to assess; some specimens could be allocated only to present-day countries, others were assignable to counties, provinces, regions, states, or more specific localities, based on label data, atlases, and gazetteers.

The number of individuals sampled from each currently recognized species (Dickinson and Remsen, 2013) and the number of haplotypes found within each are shown in table 2. Overall, the 410 sequences corresponded to 116 unique haplotypes. Nucleotide diversities, averaged over populations represented by three or more individuals, generally ranged between  $10^{-4}$  and  $10^{-3}$ , but we observed no variation among the three sampled specimens of *ruspolii* (table 2).

A minimum-spanning network for the 116 haplotypes is shown in figure 1. No haplotypes were shared between any pairs of currently recognized species. However, there were frequent instances of geographically allopatric or parapatric taxa, currently considered subspecies, that shared no haplotypes and, in many cases, were reciprocally monophyletic. In two cases, *livingstonii* and *schuettii*, the currently recognized species were not monophyletic.

The network shown (fig. 1) is one of many, and the various resolutions of all the networks resulted in 1936 alternate minimum length trees in the PAUP\* analysis. The only major differ-

TABLE 2. Genetic variation in turaco populations at the ND2 locus.<sup>a</sup>

Taxon	Individuals Sampled (no.)	Popula- tions Sampled (no.)	Haplotypes Observed (no.)	Nucleotide Diversity ( $\pi$ )	Among-population variance ( $G_{st}$ )
<i>Gallirex porphyreolophus</i>	25	11	9	0.0008	0.00
<i>G. p. porphyreolophus</i>	7	3	6	0.0016	—
<i>G. p. chlorochlamys</i>	18	8	4	0.0003	0.09
<i>G. johnstoni</i>	14	3	6	0.0011	0.63
<i>G. j. johnstoni</i>	7	1	2	0.0005	—
<i>G. j. kivuensis</i>	7	2	4	0.0016	—
<i>Menelikornis leucotis</i>	20	8	6	0.0008	0.50
<i>M. l. leucotis</i>	12	5	5	0.0010	0.08
<i>M. l. donaldsoni</i>	8	3	1	0.0000	—
<i>M. ruspolii</i>	3	1	1	0.0000	—
<i>Musophaga rossae</i>	33	7	4	0.0006	-0.19
<i>M. violacea</i>	12	6	6	0.0038	—
<i>M. macrorhyncha</i>	39	6	14	0.0014	0.78
<i>M. m. macrorhyncha</i>	12	2	5	0.0013	—
<i>M. m. verreauxii</i>	27	4	9	0.0014	0.15
<i>Proturacus bannermani</i>	4	1	2	0.0008	—
<i>P. leucolophus</i>	19	5	4	0.0011	0.18
<i>P. erythrolophus</i>	8	1	3	0.0011	—
<i>Tauraco persa</i>	44	10	8	0.0007	0.88
<i>T. p. persa</i>	26	6	5	0.0011	0.28
<i>T. p. buffoni</i>	18	4	3	0.0002	0.42
<i>T. schuettii</i>	34	8	10	0.0014	0.90
<i>T. s. schuettii</i>	17	3	6	0.0009	0.14
<i>T. s. emini</i>	17	5	4	0.0019	0.06
<i>T. hartlaubi</i>	58	11	11	0.0008	0.81
<i>T. fischeri</i>	15	5	4	0.0006	-0.05
<i>T. corythaix</i>	17	4	4	0.0002	0.83
<i>T. livingstonii</i>	32	6	8	0.0009	0.93
<i>T. l. livingstonii</i>	13	2	2	0.0004	0.41
<i>T. l. reichenowi</i>	19	4	6	0.0015	0.05
<i>T. schalowi</i>	33	8	16	0.0017	0.75
<i>T. s. chalcophus</i>	3	1	1	0.0000	—
<i>T. s. schalowi</i>	13	1	7	0.0033	—
<i>T. s. loitanus</i>	2	1	1	0.0000	—
<i>T. s. marungensis</i>	15	5	7	0.0018	0.43

<sup>a</sup>  $\pi$  and  $G_{st}$  estimated over populations with  $N \geq 3$

ences among these were that, in one third of the trees, *M. verreauxii* was paraphyletic with respect to *M. macrorhyncha* in an alternate local rooting and, in approximately 30% of the trees, either *T. schalowi* (sensu latu) or *T. schuettii* was paraphyletic with respect to the other taxon. None of the alternate trees, however, resulted in polyphyly of any of the taxa identified in figure 1, and there was no haplotype sharing anywhere in the network with the exception of two individuals of *porphyreolophus* possessing the predominant haplotype found in *chlorochlamys*.

The geographic distributions of haplotypes are shown in figures 2–6 for each of the 17 species-level taxa of musophagines recognized by Dickinson and Renssen (2013). These show the geographic pattern and extent of our sampling within those taxa, the haplotype network for each species, and suggest regions where the genetic units might contact between the sampled populations. The magnitude of genetic divergence among populations is provided by our estimates of  $G_{st}$  (table 2); in many cases, these estimates were large and reflect clades of haplotypes restricted to divergent, currently subspecific, taxa. Consequently, we also provide estimates of  $G_{st}$  within such subspecies. For example, 88% of the total genetic variation was distributed among populations of the traditional *T. persa* across the west coast of Africa, but substantially less among populations within each of our restricted *persa* and *buffoni* (table 2). In other instances, large values of  $G_{st}$  occurred within much smaller regions (e.g., *T. hartlaubi* and *M. leucotis* plus *M. donaldsoni*).

#### SPECIES DELIMITATION

Based on the pattern of geographically parapatric and allopatric clades of haplotypes found in our phylogeographic analysis, in addition to abrupt geographic transitions in plumage and soft-part morphology, as documented by Moreau (1958b), we concluded that there are 27 phylogenetic species-level taxa within the subfamily Musophaginae; these are the taxa appropriate for studies of phylogenetic diversification and historical biogeographic analysis. Our assessment incorporates phylogeography, morphology, and geography, as indicated in table 3. The associated hierarchical estimates of genetic variance, based on the ARLEQUIN results, were very high (>47%, table 3), with the sole exception of that between *G. porphyreolophus* and *G. chlorochlamys* (20%), in which a shared haplotype was found in one population.

#### PHYLOGENY

We obtained complete sequences of the mitochondrial ND2 gene from 33 taxa of musophagids. The sequences have been deposited in GenBank (KU160188–KU160218); specimen voucher data is provided in appendix 1. All sequences were 1041 bp in length, including the outgroups; there were no ambiguous bases, and they could be aligned without indels.

We obtained complete sequences of intron 15 of the nuclear aconitase-1 gene from the same 33 taxa of turacos sequenced for the ND2 gene, as well as for the same four outgroups. These sequences have been deposited in GenBank (KT372802–KT372836, MF766008–MF766009); specimen voucher data is provided in appendix 2. The sequences varied in length

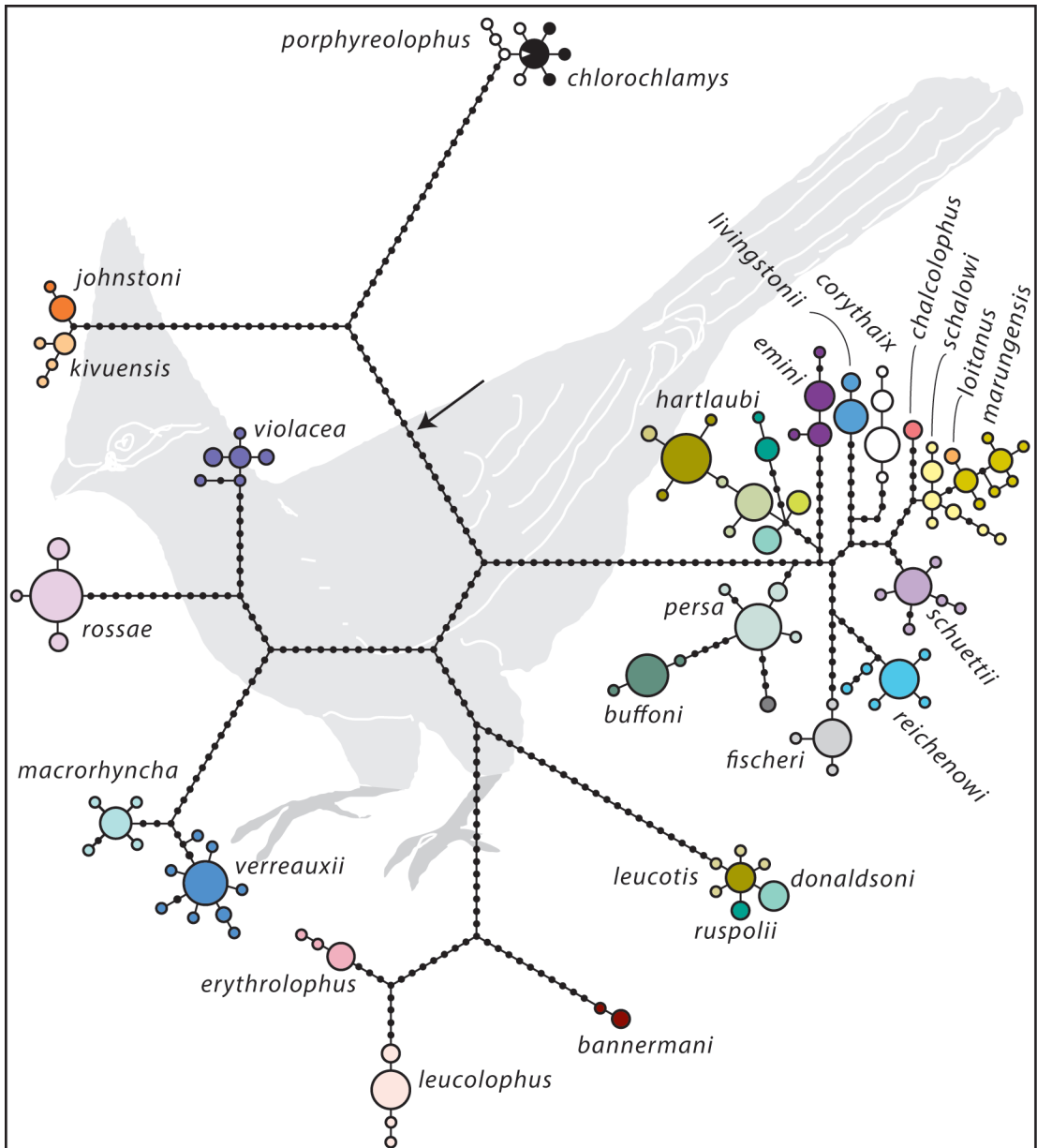

FIGURE 1. Minimum-spanning network for 116 ND2 haplotypes found among 410 individuals of musophagine turacos. Area of each pie diagram is proportional to number of individuals sampled with that haplotype; black dots indicate positions of unobserved (inferred) ancestral haplotypes. Approximate position of branch from sister taxa of Musophagidae indicated by arrow. Alternate colors and names correspond to species-level taxa recognized here.

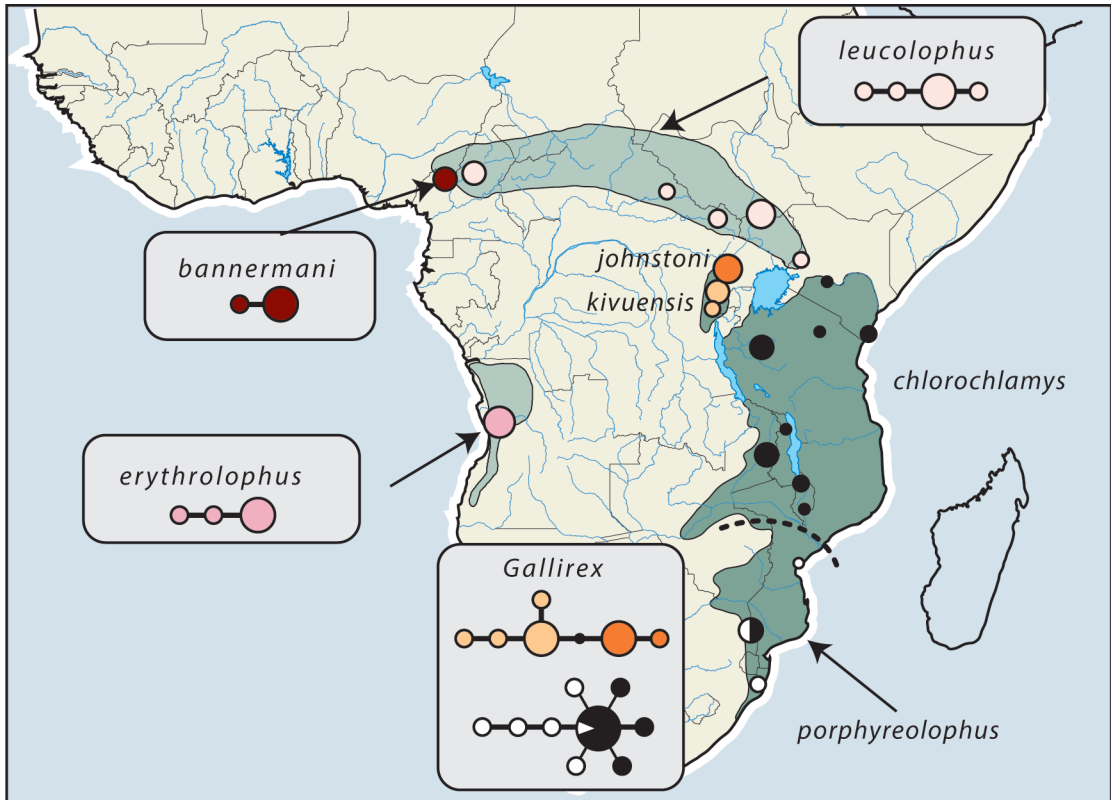

FIGURE 2. Geographic distribution of ND2 haplotypes in the *Gallirex* and *Proturacus* complexes. Approximate geographic ranges of taxa are indicated by colored shading (*Gallirex* in dark green; *Proturacus* in light green). Areas of pie diagrams on map are proportional to sample sizes at each locality. Colors of pie diagrams are keyed to haplotype networks shown in associated capsules, where area of haplotype circle is again proportional to sample size. Approximate position of division between *G. porphyreolophus* and *G. chlorochlamys* phenotypes (Zambesi River), based on Moreau (1958b), is indicated by dashed line.

from 544 bp to 560 bp among the musophagids, and from 549 bp to 562 bp among the outgroups. We obtained an overall alignment of 574 bp; this required ten indels within the ingroup, four of which represented synapomorphies. There were 16 indels inferred among the outgroups. The ACO1 gene resides on the Z chromosome in birds and consequently is diploid in males and haploid in females; we observed a range of heterozygosities within individuals of 0.0 to 0.009 among the turacos.

We obtained new nuclear RAG-1 sequences from 23 taxa of musophagids and two outgroups for which preserved tissues were available. The sequences have been deposited in GenBank (KT424072–KT424096); specimen voucher data are provided in appendix 3. The sequenced fragment is identical to that described by Groth and Barrowclough (1999); it corresponds to base pairs 84 through 2967 of the *Gallus* gene (GenBank: M58530; Carlson et al. 1991). We also used the RAG-1 sequence of one additional species of turaco (*P. erythrolophus*: DQ482643) previously deposited in GenBank. The four outgroups represent the same taxa used



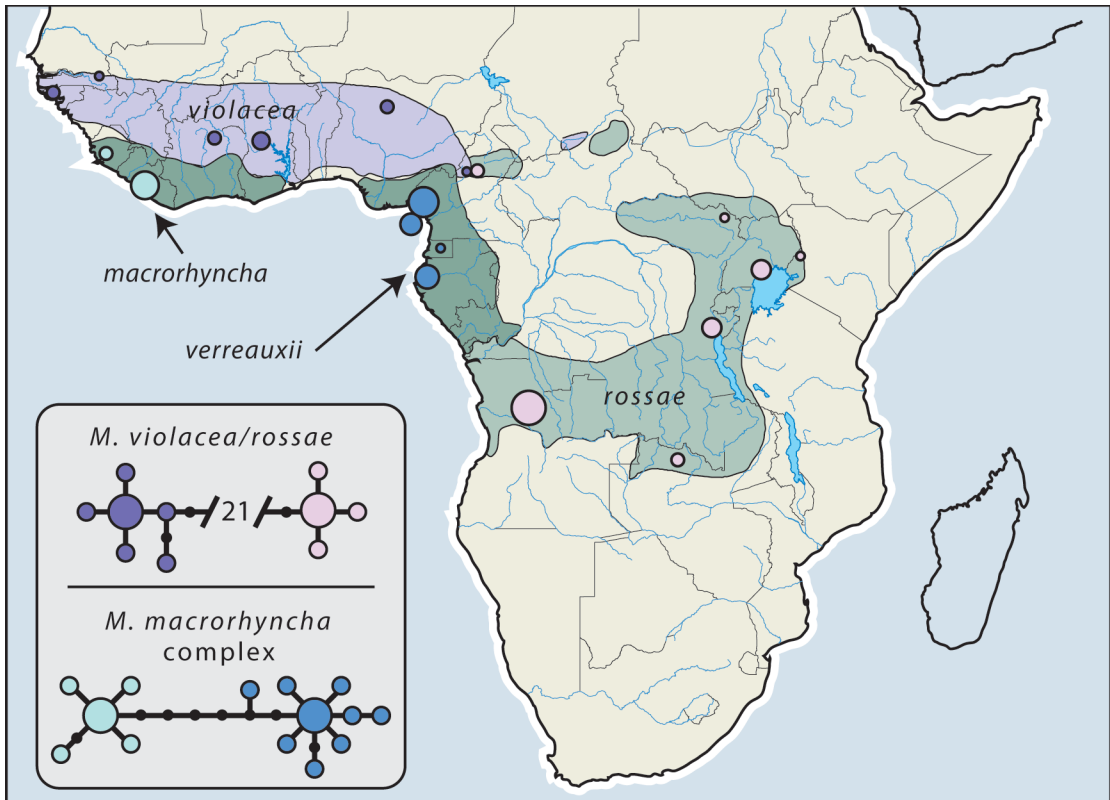

FIGURE 3. Geographic distribution of ND2 haplotypes in turacos of the genus *Musophaga*. Approximate geographic range of the *macrorhyncha* complex is indicated in dark green, that of *rossae* in light green, and of *violacea* in violet. Areas of pie-diagrams on map are proportional to sample sizes at each locality. Colors of pie diagrams are keyed to haplotype networks shown in capsule; area of haplotype circle is proportional to sample size.

for the other genes. A single, 3 bp indel in one outgroup (*Antigone canadensis*) was required to align the sequences. The overall alignment of the gene fragment was 2872 bp in length; heterozygosity ranged from 0.0 to 0.006 for this autosomal gene. No length heterozygotes were encountered in either of the nuclear loci.

We used PAUP\* to infer maximum likelihood trees, along with bootstrap confidence indices, for each of the three genes using a GTR plus G model of sequence evolution, based on the MODELTEST AIC results. The ND2 and ACO1 trees both included 33 taxa of musophagids; their bootstrap consensus trees are shown in figure 7 (outgroups not shown). The RAG-1 analysis included the reduced set of 24 ingroup taxa for which fresh tissues were available (fig. 8), plus the four outgroups (not shown). Each of the three genes resulted in monophyletic clades corresponding to the three traditional subfamily-level taxa. In fact, the only major discordance among the three trees was the position of *Corythaeola* in the two nuclear trees versus the mitochondrial tree. For the ND2 and ACO1 results, three minor discrepancies also occurred within species groups (figure 7); in two of those cases, high bootstrap support from ND2 conflicted with weak bootstrap support from ACO1. For example, *P. leucolophus* was sister to *P.*

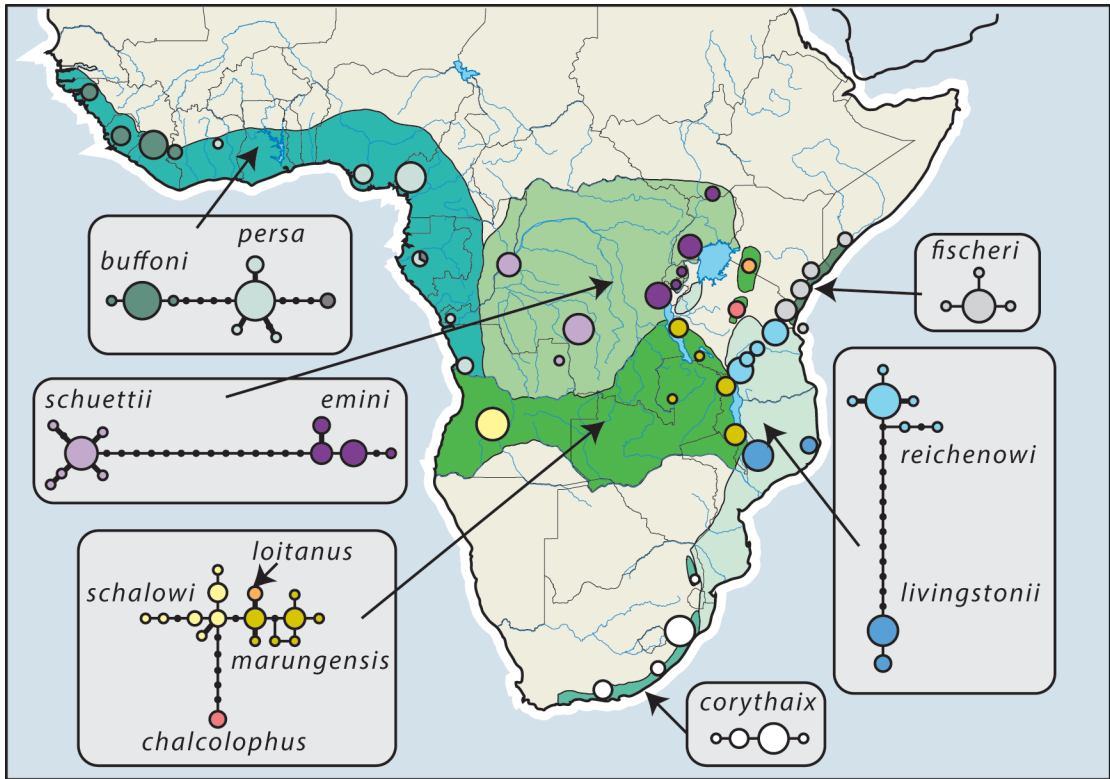

FIGURE 4. Geographic distribution of ND2 haplotypes in several currently recognized species (Dickinson and Remsen, 2013) of green turacos (*Tauraco*) across forested portions of Africa; approximate ranges of taxa are indicated by alternate shades of green. Areas of pie diagrams are proportional to sample sizes at each locality. Colors of pie-diagrams are keyed to haplotype network shown in capsule for each species complex.

*erythrolophus* in the ND2 tree, but sister to *P. bannermani* in the ACO1 tree. The four synapomorphic indels at the ACO1 locus, not used in our phylogenetic inference, nevertheless were each consistent with nodes that also had appreciable bootstrap support. The RAG-1 results (fig. 8) were generally consistent with the other two trees; some minor discrepancies within the green turaco complex were present, but lacked bootstrap support.

We performed a combined analysis of the three genes using Garli. Each gene was treated as a separate partition, using GTR plus G models, with bootstrap replicates. The resulting consensus (fig. 9) placed *Corythaeola* with the go-away-birds (90% bootstrap) and showed more hierarchical structure within the Musophaginae than did any of the three individual gene trees.

Our ND2 sequences placed *Corythaeola* as sister to the turacos, whereas the two nuclear loci placed it as sister to the go-away-birds; a prior mitochondrial study had placed *Corythaeola* as sister to the rest of the family (Veron and Winney, 2000). Because base composition heterogeneity can interfere with phylogenetic reconstruction, we examined base composition in the three loci used here. For both RAG-1 (fig. 10) and ACO1 (not shown), there was little variation in base composition within the Musophagidae; however, for ND2 (fig. 11) variation was substantial within the ingroup,



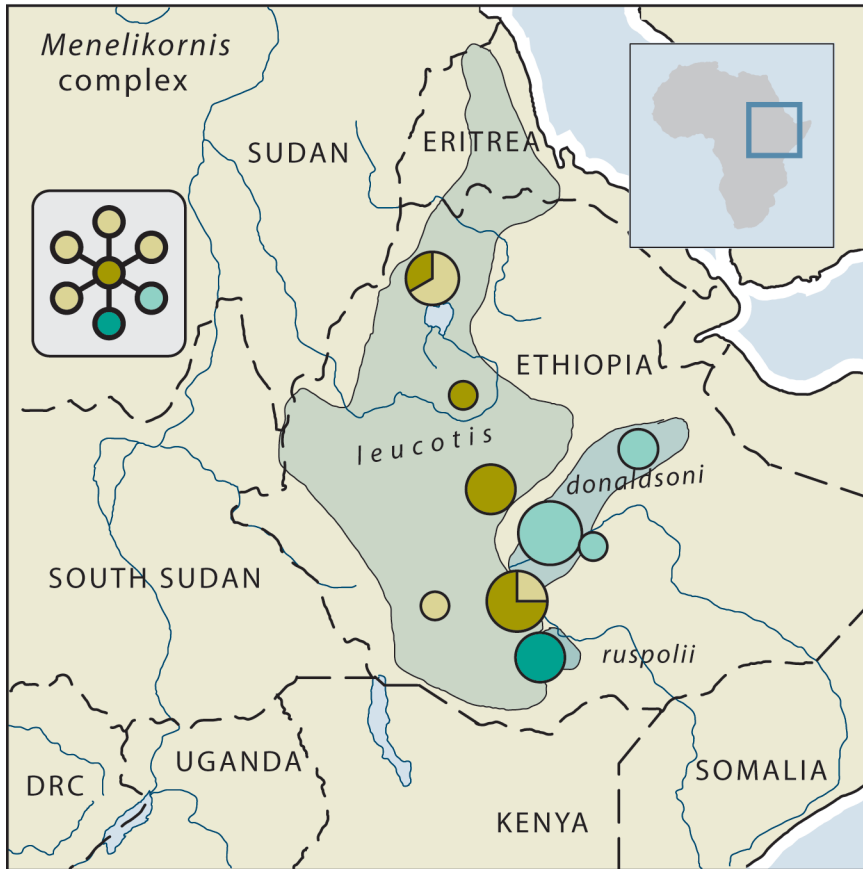

FIGURE 5. Geographic distribution of ND2 haplotypes in the *Menelikornis* complex in the Ethiopian highlands; approximate ranges of three taxa in the complex are indicated by alternate colors. Areas of pie diagrams on map are proportional to sample sizes at each locality. Colors of pie diagrams are keyed to haplotype network shown in capsule.

and especially within the go-away-birds, as it was among the outgroups. In particular, *Corythaeola* possessed an A nucleotide fraction within the range of that of the turacos, but substantially greater than that of the go-away-birds. For C nucleotides, *Corythaeola* was closer to *Gallirex*, sister to the rest of the musophagines, than it was to mean of the widely dispersed criniferines. These three subfamilies are from 14% to 17% divergent for ND2 and it is possible that base composition heterogeneity may have attracted *Corythaeola* to the musophagine portion of the evolutionary network for this mitochondrial gene and interfered with recovering actual evolutionary relationships.

## DISCUSSION

### PHYLOGEOGRAPHY AND SPECIES LIMITS IN THE MUSOPHAGINAE

Based on our analyses of the mtDNA sequences and our assessment of prior descriptions of the external morphology of the birds, we treat allopatric or parapatric forms that are diag-

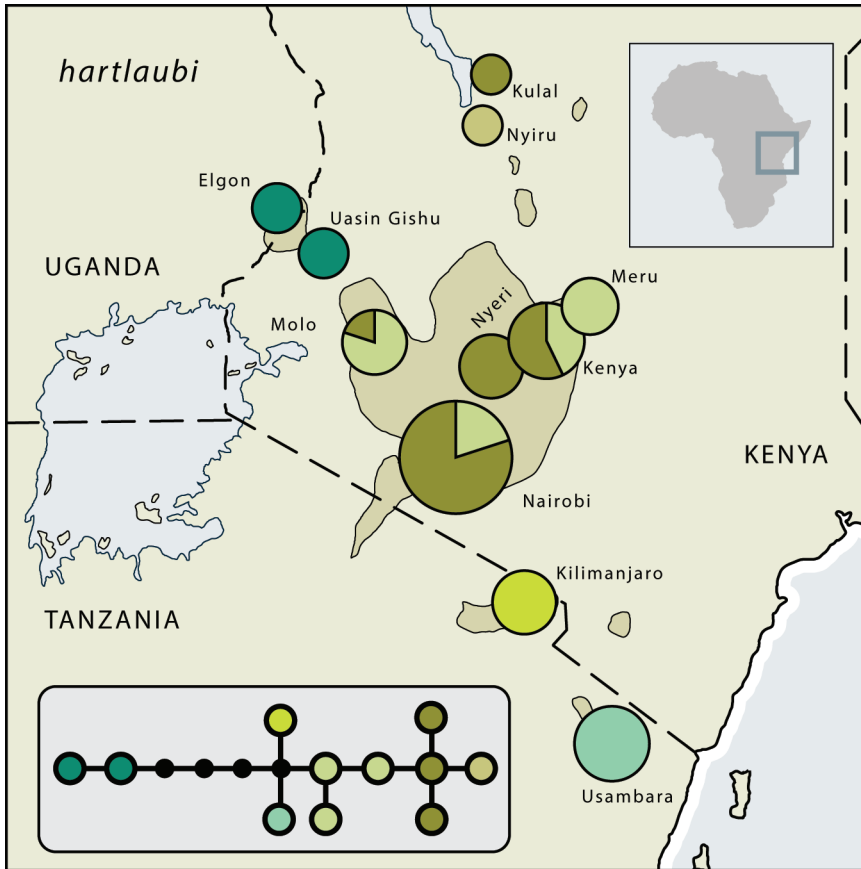

FIGURE 6. Geographic distribution of ND2 haplotypes of *Tauraco hartlaubi* across East Africa. Areas of pie diagrams on map are proportional to sample sizes at each locality. Colors of pie diagrams are keyed to haplotype network shown in capsule. Darker tan on map indicates 1500 m contour.

nosable as phylogenetic species (Barrowclough et al., 2016). These are the proper units for studies of evolutionary divergence and historical biogeography; they document diversity hidden in current avian species lists (Collar, 2018). In addition, they play a critical role in setting priorities for conservation planning (Peterson and Navarro-Sigüenza, 1999; Goldstein et al., 2000). In the absence of detailed behavioral data, it is not evident whether each of these corresponds to a traditional biological species. Nevertheless, our results reinforce the suggestion of Barrowclough et al. (2016) that there is substantial unrecognized phylogenetic divergence in birds. Below we discuss each taxon given species rank in the most recent, widely used classification, that of Dickinson and Remsen (2013).

*Gallirex johnstoni*: Short et al. (1990) suggest that “Rwenzori” is the proper spelling for the vernacular of this turaco. The two currently recognized subspecies, *G. j. johnstoni* and *G. j. kivuensis*, have ranges that are allopatric (fig. 2). They possess discrete differences in plumage and soft-part coloration (Moreau, 1958b; Forshaw and Cooper, 2002), and their mitochondrial haplotype networks resolve as two differentiated (table 3), reciprocally monophyletic clades

TABLE 3. Diagnostic characteristics of newly recognized species-taxa of turacos.<sup>a</sup>

New species-level taxon	Prior taxonomic treatment (Dickinson and Remsen 2013)	Hierarchical $F_{st}$ between species taxa	Differentiation
<i>Gallirex chlorochlamys</i>	<i>G. porphyreolophus chlorochlamys</i>	0.20	ND2: 100% of <i>chlorochlamys</i> distinguishable from 71% of <i>porphyreolophus</i> , based on one shared haplotype (83% in <i>chlorochlamys</i> and 28% in <i>porphyreolophus</i> ) and additional haplotypes restricted to one or other PLUMAGE: no brownish-pink wash on breast and back of <i>chlorochlamys</i> (Moreau, 1958b; Forshaw and Cooper, 2002) SOFT PARTS: patch before eye bare; not feathered as in <i>porphyreolophus</i> (e.g., Forshaw and Cooper, 2002) GEOGRAPHY: <i>chlorochlamys</i> and <i>porphyreolophus</i> probably parapatric across the Zambesi River (Moreau, 1958b); possible intergradation near edge of range in north central Zimbabwe (Smithers, 1951)
<i>Gallirex kivuensis</i>	<i>G. johnstoni kivuensis</i>	0.79	ND2: <i>johnstoni</i> and <i>kivuensis</i> 100% diagnosable and reciprocally monophyletic SOFT PARTS: skin around eye feathered in <i>kivuensis</i> , not brightly colored as in <i>johnstoni</i> (e.g., Forshaw and Cooper, 2002) GEOGRAPHY: allopatric (Moreau, 1958b)
<i>Menelikornis donaldsoni</i>	<i>Tauraco leucotis donaldsoni</i>	0.67	ND2: <i>donaldsoni</i> and <i>leucotis</i> 100% diagnosable. PLUMAGE: crest red in <i>donaldsoni</i> ; blue in <i>leucotis</i> (e.g., Forshaw and Cooper, 2002) GEOGRAPHY: allopatric (Moreau, 1958b)
<i>Musophaga verreauxii</i>	<i>Tauraco macrorhynchos verreauxii</i>	0.88	ND2: <i>verreauxii</i> and <i>macrorhynchos</i> 100% diagnosable and reciprocally monophyletic PLUMAGE: green crest with terminal red border in <i>verreauxii</i> ; green with white subterminal and blue terminal border in <i>macrorhynchos</i> (e.g., Forshaw and Cooper, 2002). GEOGRAPHY: allopatric (Moreau, 1958b)
<i>Tauraco buffoni</i>	<i>T. persa buffoni</i>	0.90	ND2: <i>persa</i> and <i>buffoni</i> 100% diagnosable PLUMAGE: <i>buffoni</i> lacks white line below eye found in <i>persa</i> (e.g., Forshaw and Cooper, 2002) GEOGRAPHY: parapatric; possible narrow hybrid zone in Ivory Coast (Moreau, 1958b)
<i>Tauraco emini</i>	<i>T. schuettii emini</i>	0.95	ND2: <i>emini</i> and <i>schuettii</i> 100% diagnosable; reciprocally monophyletic; they are not sister taxa PLUMAGE: back, wings, thighs, and upper tail bright green in <i>emini</i> ; violet-blue-black in <i>schuettii</i> (Moreau, 1958b; Forshaw and Cooper, 2002) GEOGRAPHY: parapatric; possible hybridization in northeastern Democratic Republic of Congo (Chapin, 1939; Moreau, 1958b)

TABLE 3 *continued*

New species-level taxon	Prior taxonomic treatment (Dickinson and Remsen 2013)	Hierarchical $F_{st}$ between species taxa	Differentiation
<i>Tauraco reichenowi</i>	<i>T. livingstonii reichenowi</i>	0.96	ND2: <i>reichenowi</i> and <i>livingstonii</i> 100% diagnosable; reciprocally monophyletic; they are not sister taxa PLUMAGE: subtle, inconsistent (Chapin, 1939) differences of green versus blue on back, wings, and tail GEOGRAPHY: parapatric?; possible hybrid zone (Moreau, 1958b)
<i>Tauraco chalcophus</i>	<i>T. schalowi</i> (part)	0.74	ND2: <i>chalcophus</i> is 100% diagnosable from, and sister to, the rest of the <i>schalowi</i> complex PLUMAGE: white line under eye absent in <i>chalcophus</i> ; crest and nape feathers with blue gloss (Moreau, 1958b) GEOGRAPHY: allopatric (Moreau, 1958b)
<i>Tauraco loitanus</i>	<i>T. schalowi</i> (part)	0.60	ND2: <i>loitanus</i> is 100% diagnosable from the rest of the <i>schalowi</i> complex PLUMAGE: cryptic (Moreau, 1958b) GEOGRAPHY: distantly allopatric (Moreau, 1958b)
<i>Tauraco marungensis</i>	<i>T. schalowi</i> (part)	0.47	ND2: <i>marungensis</i> is 100% diagnosable from the rest of the <i>schalowi</i> complex PLUMAGE: cryptic (Chapin, 1939; Moreau, 1958b) GEOGRAPHY: parapatric or possibly allopatric in eastern Angola or western Zambia (Moreau, 1958b); possible contact unknown

<sup>a</sup> Diagnoses of plumage and soft part characters based on Chapin (1939), Moreau (1958b), and Forshaw and Cooper (2002).

(fig. 1). These represent two phylogenetic species. Their divergence is most likely the result of a history of isolation within high-elevation, montane forest fragments that are separated from each other by unsuitable, lower-elevation habitat. Moreau (1958b) thought a third taxon, *G. j. bredoi*, confined to Mt. Kabobo in the Democratic Republic of Congo, possessed “good” characters, but he later (Moreau, 1958c) changed his opinion, based on the examination of additional specimens. We were not able to examine any specimens during this research.

*Gallirex porphyreolophus*: The purple-crested turaco occurs from southern Kenya to the northeastern portion of the Republic of South Africa. The two generally recognized subspecies, *G. p. porphyreolophus* and *G. p. chlorochlamys*, have discrete well-marked differences in both plumage pattern and soft parts, as described by Moreau (1958b) and illustrated by Forshaw and Cooper (2002). Moreau (1958b), based on his examination of the large series at the British Museum, suggested the taxa were isolated by the Zambesi River; all (22) specimens at the AMNH are consistent with that interpretation (appendix 4). The suggestion of intergradation between these two (Moreau, 1958b) appears to be based on a few specimens, with reduced brownish pink on their breast and mantle, taken from the upper Zambesi and its tributaries, toward the western

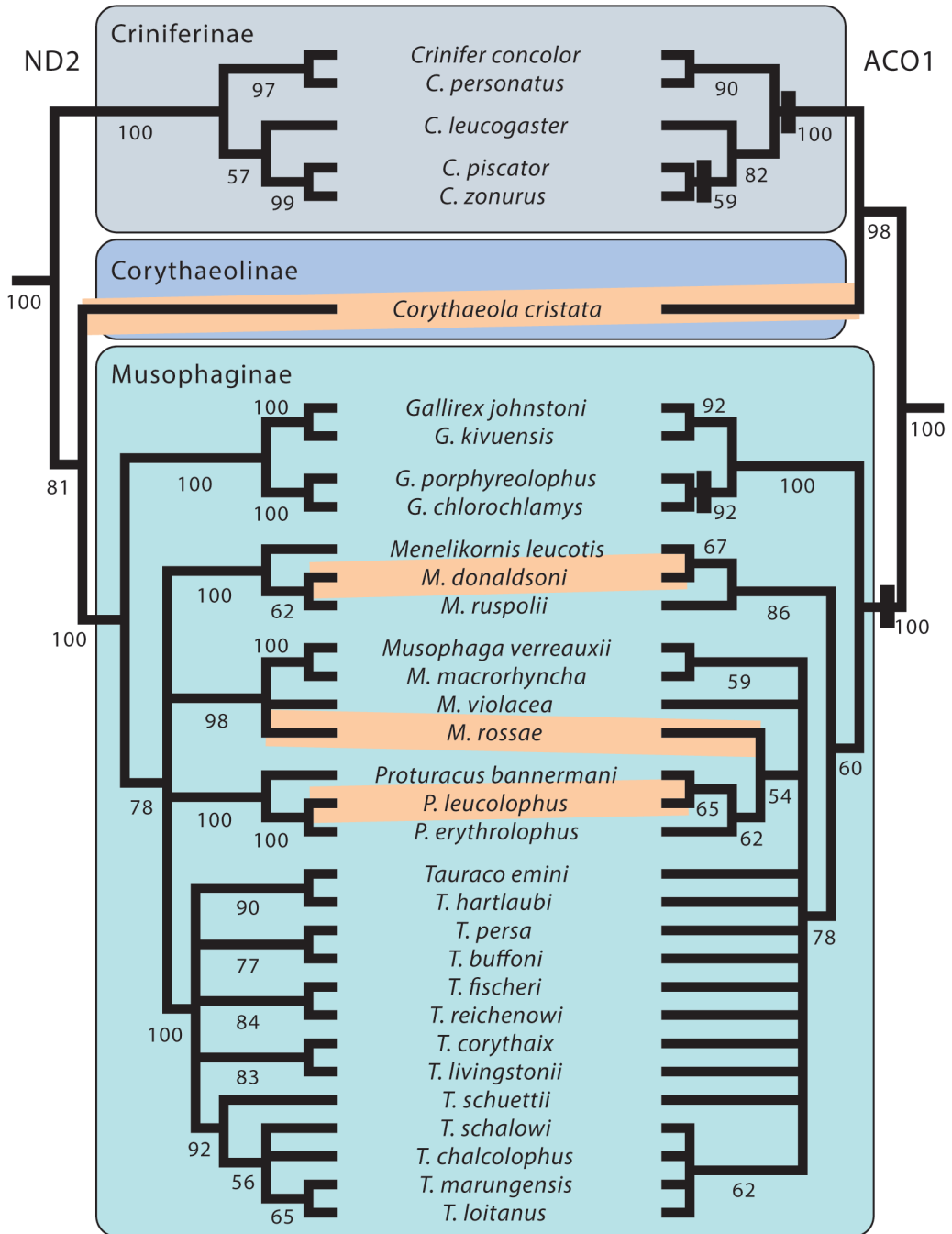

FIGURE 7. Bootstrap consensus maximum likelihood trees for complete ND2 and ACO1-115 DNA sequences of species-level taxa of turacos; bootstrap values indicated for nodes with greater than 50% support. Phylogenetic positions of four synapomorphic indels among the ACO1 sequences are indicated by vertical bars. Four conflicts between the two genes are indicated.

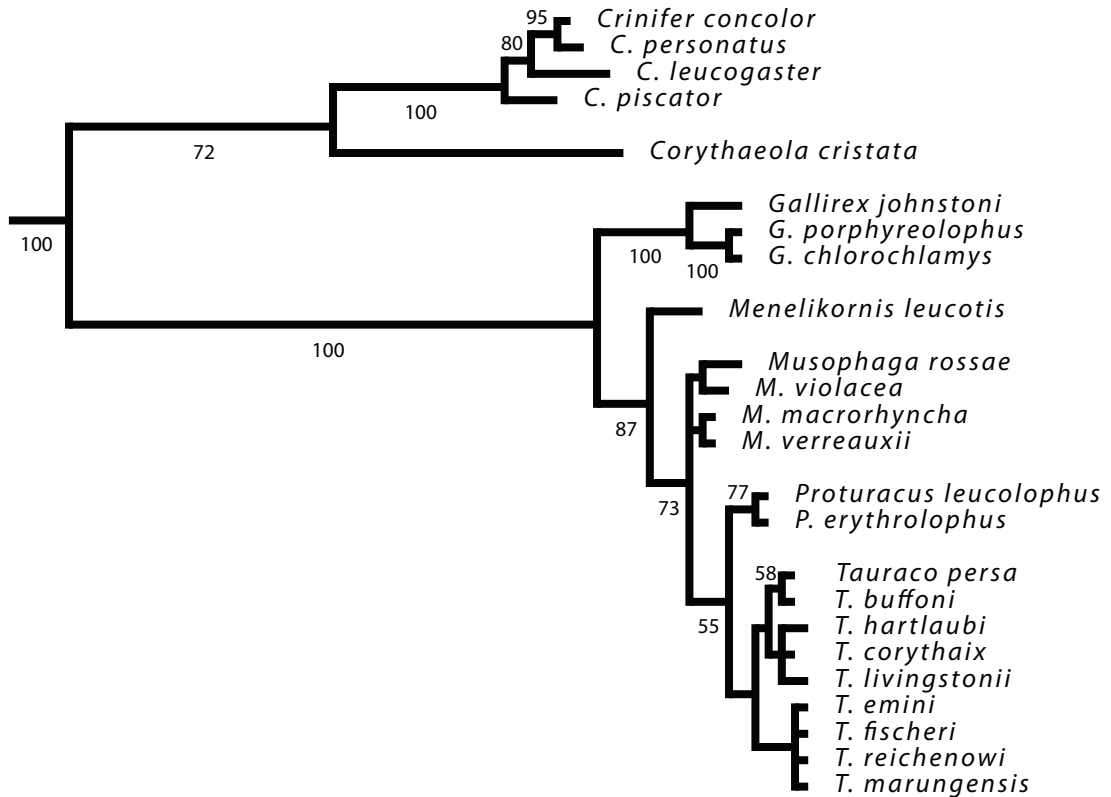

FIGURE 8. Maximum likelihood phylogram for 24 species-level taxa of turacos based on sequences of the RAG-1 exon. Bootstrap values indicated for nodes with greater than 50% support.

edge of the taxon's range in present day Zambia and Zimbabwe (Smithers, 1951). We have not seen those specimens; they might be relevant under the biological species concept, but not under a phylogenetic concept in which historical isolation trumps limited hybridization.

We found several private haplotypes restricted to one or the other taxon, and a single haplotype present at high frequency in *chlorochlamys* (83%) and at low frequency (28%) in *porphyreolophus* (fig. 2). The occurrence of that common haplotype in *porphyreolophus* was not proximal to the edge of the range of *chlorochlamys*, near the Zambesi, where one might expect it on the basis of hybridization, but rather in the center of the range in the South African Mpumalanga Province (formerly Transvaal), consistent with a hypothesis of incomplete lineage sorting. The two Mpumalanga specimens that possessed the common, *chlorochlamys* ND2 haplotype (AMNH624120 and AMNH624123) both possess the diagnostic *porphyreolophus* character traits of brownish-pink breast and a reduced bare spot in front of the eye (appendix 4). This complex clearly merits future investigation, but, for the present, we recognize two phylogenetic species, based on the combination of mtDNA and morphology, the apparent result of geographic isolation in the relatively recent (e.g., incomplete lineage sorting) past.

*Menelikornis leucotis*/*M. ruspolii*: Our data indicate that the two currently recognized subspecies of white-cheeked turaco, along with Prince Ruspoli's turaco, are a closely related

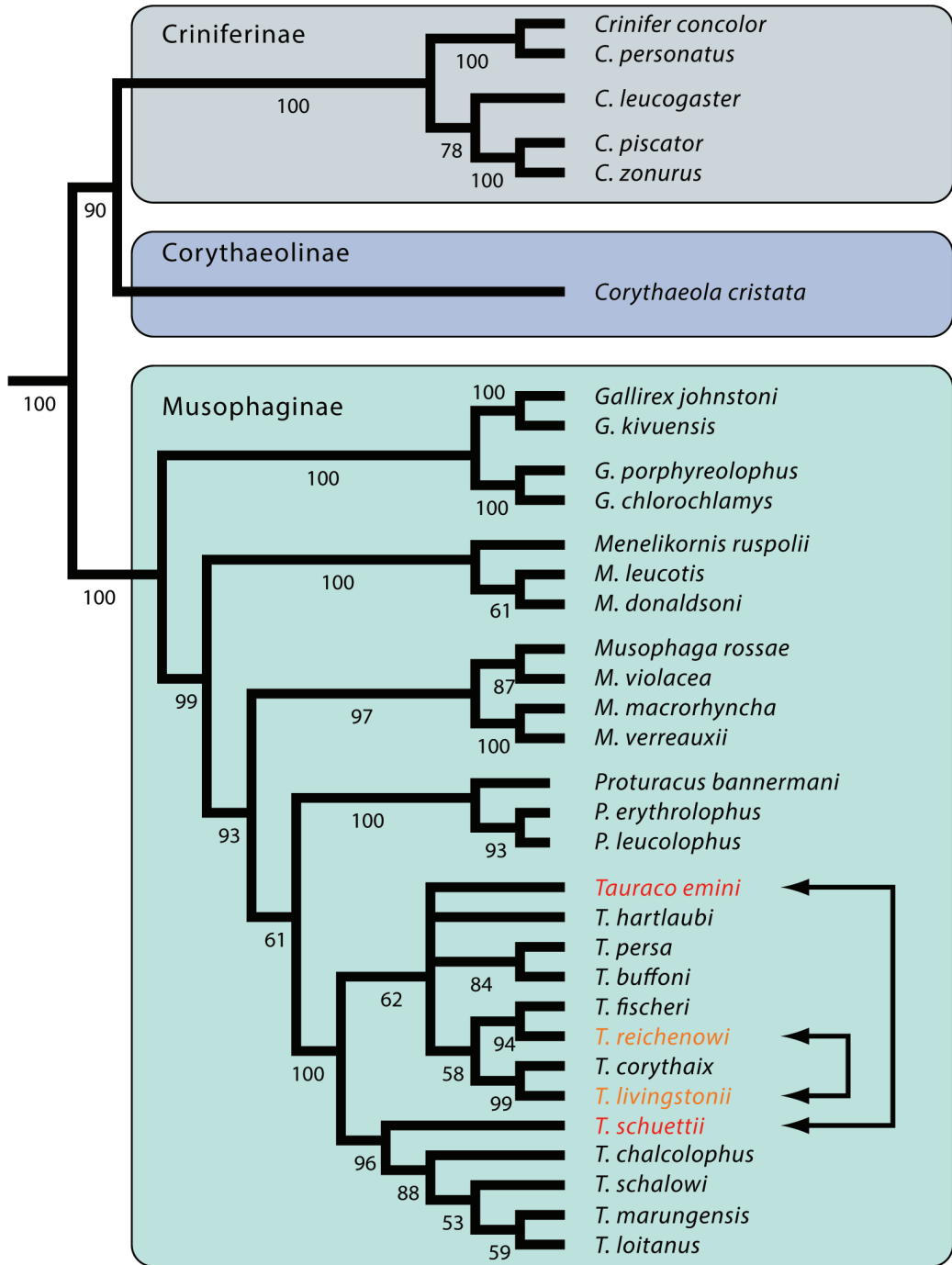

FIGURE 9. Phylogenetic relationships among species-level taxa of turacos based on partitioned maximum likelihood analysis of ND2, ACO1-I15, and RAG-1 DNA sequences; bootstrap values indicated for nodes with greater than 50% support. Polyphyletic relationships of taxa within two currently recognized biological species (e.g., Dickinson and Remsen, 2013) are highlighted with arrows and alternate colors.

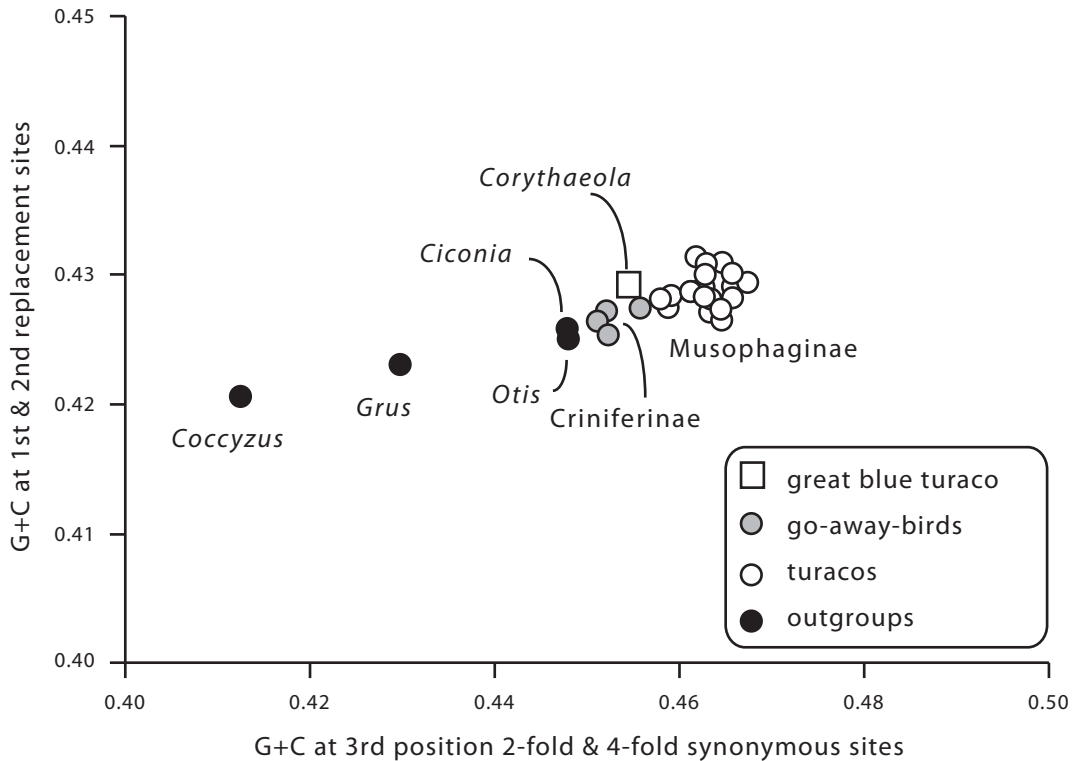

FIGURE 10. Base composition variation among 24 taxa of the Musophagidae and 4 outgroups at the nuclear RAG-1 locus.

geographical assemblage (fig. 1) in northeast Africa (fig. 5). The three are diagnosable based on either our ND2 sequences or the morphological characters described by Moreau (1958b) and depicted in Forshaw and Cooper (2002). *M. donaldsoni* was as genetically divergent from *leucotis* as was *ruspolii*. They represent three allopatric, species-level taxa. Nucleotide divergence within the *leucotis* complex,  $G_{st}$ , was 0.5, and the hierarchical  $F_{st}$  was 0.67; these values were almost entirely due to the inclusion of the *donaldsoni* samples with those of *leucotis* (table 2, table 3). We did not find any genetic variation in either *donaldsoni* or *ruspolii*.

*Musophaga rossae*: Lady Ross's turaco, a monotypic species, has an extensive distribution through much of the southern and eastern Congo River Basin and its fringes (fig. 3). Nevertheless, it showed less genetic divergence over that range than the statistical error associated with our population samples (table 2). A sample from an isolated population from northern Cameroon shared haplotypes with a population sample from eastern Haut-Zaire, more than 1500 km away; this suggests that recently a more extensive distribution must have existed across the northern edge of the Congo Basin.

*Musophaga violacea*: The monotypic violet turaco showed substantial nucleotide diversity in our sample from Ghana (table 2). Although the species has a wide geographic distribution from Senegal to Cameroon (fig. 3), five of our six samples were smaller than



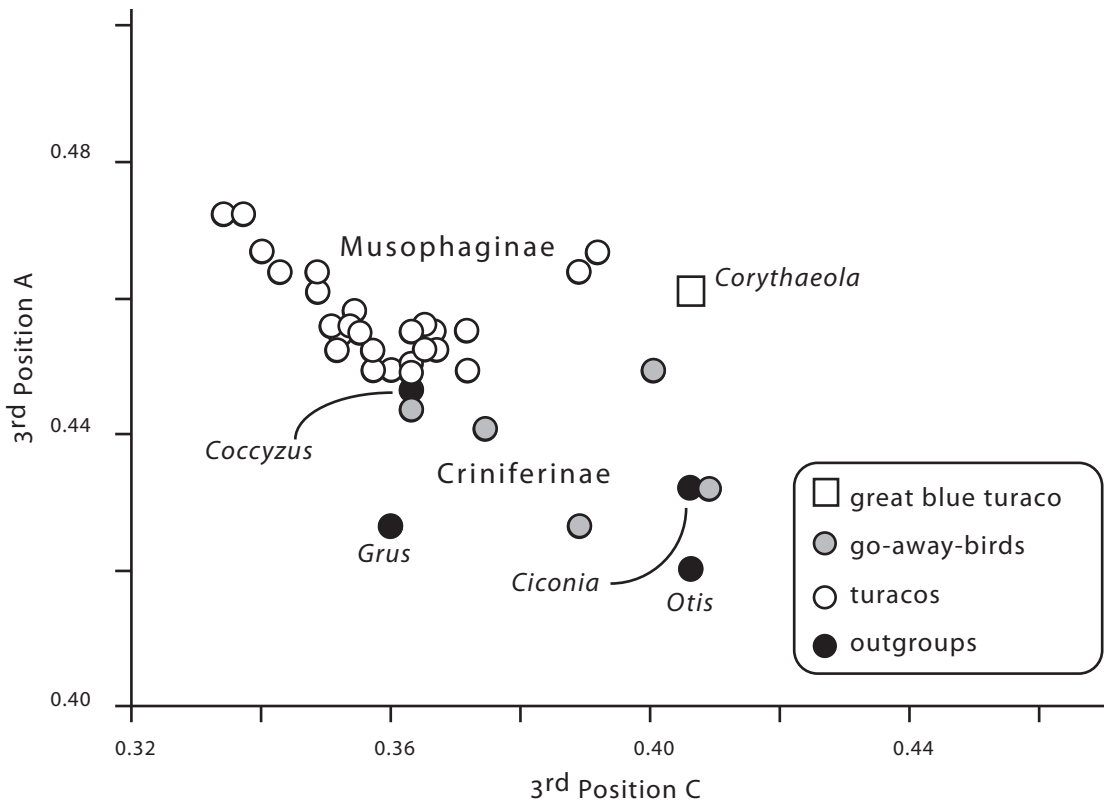

FIGURE 11. Base composition variation among 33 taxa of the Musophagidae and 4 outgroups at the mitochondrial ND2 gene.

three individuals per population; consequently, we did not calculate  $G_{st}$  across the range. We note, however, that the Senegal and Guinea-Bissau samples were fixed for a haplotype, two substitutions divergent from any others, that was not found east of those locations; this suggests there may be some additional structure within western Africa. We were not able to examine any specimens of this species from an isolated population in northeastern Central African Republic/southern Chad; a note by Moreau (1958b) suggests that population may be morphologically divergent.

*Musophaga macrorhyncha*: Although it has a range extending from Sierra Leone in West Africa to northern Angola on the west coast of central Africa, there is a discontinuity in the range of the yellow-billed turaco across the Dahomey Gap (Moreau, 1958b; Brosset and Fry, 1988). This gap also separates the ranges of the two described taxa, *M. macrorhyncha* to the west and *M. verreauxii* to the east. Our data suggest the gap also marks the division between two distinct, reciprocally monophyletic clades of haplotypes (fig. 1, fig 3) that were responsible for most (88%) of the overall genetic variance (table 3). These two taxa are well marked morphologically, with, among other traits, red versus blue crests (Moreau, 1958b; Forshaw and Cooper, 2002). They represent two phylogenetic species with the Dahomey Gap as a biogeographic barrier.

*Proturacus bannermani*: Bannerman's turaco is known from high montane forest (above 1700 m) from a single range in western Cameroon (fig. 2); it is monotypic. We found two haplotypes among four sequenced specimens (table 2).

*Proturacus erythrolophus*: The red-crested turaco has a restricted geographical range along the coast of Angola; there are no described subspecies. Our eight samples all derive from the central portion of that range (fig. 2) and showed moderate variation (table 2).

*Proturacus leucolophus*: The white-crested turaco has a range across north-central Africa from Nigeria to Kenya. We observed moderate nucleotide diversity among five population samples. Genetic variance among these samples was significant (0.18). This was the result of three private haplotypes, one restricted to Cameroon and two to the Democratic Republic of the Congo; however, both those locality samples possessed the widespread, common haplotype.

*Tauraco corythaix*: The Knysna turaco has a distribution along the South African coast from Cape Province to KwaZulu-Natal and Swaziland, with an isolated population (*T. c. phoebus*) in the highlands of Limpopo and Mpumalanga Provinces (Moreau, 1958b). We identified four haplotypes in the four populations we sampled (fig. 4). Nucleotide diversity was low because the variation was largely distributed among, rather than within, populations ( $G_{st} = 0.83$ , table 2). In fact, our single sample of *phoebus* possessed a haplotype not found elsewhere and our sample of four individuals from the Cape Province also was fixed for a private haplotype. This species shows little variation in plumage; *phoebus* is not a well-marked subspecies (Moreau, 1958b), but the distribution of fixed private haplotypes suggests there may be genetic differentiation within this species. This bird requires further investigation with denser geographic sampling.

*Tauraco fischeri*: Fischer's turaco has a restricted range on the coast of East Africa, with a separate subspecies on Zanzibar (fig. 4). We found one common haplotype, plus three singletons, in samples from five localities. Nucleotide diversity was low and divergence among populations did not exceed sampling error (table 2). We sequenced one of the two extant specimens from the Zanzibar population (*T. f. zanzibaricus*); it had a unique haplotype one substitution away from the most common haplotype found on the mainland. We agree with Pakenham (1938) and Moreau (1958b) that these birds possess a markedly bluer back than do the Kenya and Tanzania birds. Therefore, it is plausible that the Zanzibar birds represent a separate taxon; however, with a single sequence only one step away from the common, mainland haplotype, we are unable to determine whether the island population is fixed for a novel haplotype or simply possesses a local polymorphism. The situation requires further molecular and morphological investigation.

*Tauraco hartlaubi*: Hartlaub's turaco is found in the highlands and on isolated mountain ranges and volcanoes of East Africa in Kenya, northern Tanzania, and eastern Uganda. We found several common haplotypes distributed widely among our central Kenyan population samples, but the geographic isolates elsewhere in the range were largely fixed for private haplotypes, rendering several populations, for example, those of Mt. Elgon, Kilimanjaro, and the Usambara Range, 100% diagnosable (fig. 6). This geographic pattern was associated with 81%

of the genetic variance distributed among populations (table 2). It is probable that there are several species-level taxa within this complex. However, the toe pad samples were not adequate for substantive nuclear DNA sequencing and morphological variation among the isolated populations was minimal. Consequently, we have chosen not to describe new taxa solely based on a fragment of one mitochondrial gene. The *hartlaubi* complex deserves substantial additional field and lab work.

*Tauraco livingstonii*: We identified two clades of Livingstone's turaco, not each other's closest relatives (figs. 1, 9), which corresponded to described subspecies from northern and southern portions of the species range (fig.4). The clades were 14 substitutions apart, and 96% of the genetic variance was distributed between the subspecies (table 3). Unfortunately, our population samples were not uniformly distributed over space, and we had no samples from the far southern portion of the range. Nevertheless, our results would seem to place the transition between the haplotype clades in southern Tanzania or northern Mozambique. This division does not closely correspond to published descriptions of the ranges of the morphologically based (blue-green vs. green plumage on back) subspecies, *livingstonii* and *reichenowi* (e.g., Moreau, 1958b; Forshaw and Cooper, 2002; Dickinson and Remsen, 2013).

Dickinson and Remsen (2013) restrict their *T. l. livingstonii* to the highlands of southern Malawi, west through adjacent Mozambique, to eastern Zimbabwe. Forshaw and Cooper (2002) give it a larger range, extending north to southwestern Tanzania. Both treatments correspond to interior versus more coastal distributions, as does Map V of Clancey (1971) and the discussion of Moreau (1958b). Turner (1997) similarly restricted *livingstonii*, but also limited his coastal *reichenowi* subspecies by recognizing a third taxon, *T. l. cabanisi*, for the southern coastal populations. Further sampling is clearly warranted here, but our results strongly support the existence of two unrelated species with northern and southern, rather than eastern and western ranges. The type locality of *livingstonii* is southern Malawi (Nyasaland) and that of *reichenowi* is in central east Tanzania (Tanganyika Territory); thus, we assign our southern species the name *livingstonii*, and our northern taxon the name *reichenowi*. The extent and geographic distribution of morphological variation in this bird is complex (Moreau, 1958b), and now clearly requires further evaluation.

*Tauraco persa*: The green turaco has an extensive range across West Africa from Senegal to Cameroon and south to Angola. We found two clades of haplotypes that correspond to regions west (*T. buffoni*) and east (*T. persa*) of Ivory Coast (fig. 4). Most of the genetic variation in the complex was distributed between those two regions (table 3). These represent two well-differentiated, morphologically (Moreau, 1958b; Forshaw and Cooper, 2002) as well as genetically, phylogenetic species. The division between them appears to be west of the well-known Dahomey Gap; this is consistent with the subspecific distributions reported by Moreau (1958b). *T. p. zenkeri* is an occasionally recognized taxon with a distribution to the east of our available samples; it requires further investigation.

*Tauraco schalowi*: Schalow's turaco, as traditionally recognized, has a range from Angola, east across Zambia, through the southeastern portion of the Democratic Republic of Congo, to the Rift Valley lakes. There are two additional isolated populations that have been named,

but not generally recognized: one in the Crater and Mbulu highlands of central Tanzania (*T. s. chalcophus*) and the other in the Loita Hills of southwestern Kenya (*T. s. loitanus*). Although the birds appear quite similar in plumage across this range (Moreau, 1958b), we found a complex pattern of differentiated haplotypes (fig. 4) and a large fraction (75%) of genetic variation distributed among regions (table 2). First, our sample of *chalcophus* from Tanzania was fixed for a haplotype, found nowhere else, that placed that population as sister to the rest of the complex (fig. 1). Our Angola sample, from the western portion of the range (*schalowi*), possessed a network of haplotypes that was restricted to that country (fig. 3). Derived from within that network was a clade of eight haplotypes present only in the eastern portion of the bird's range. One of those was fixed in a small sample from the allopatric population in the Loita Hills (*loitanus*); the remaining seven (*marungensis*) were found in the eastern contiguous portion of the range. Consequently, there were two probably parapatric and two completely allopatric taxa in the complex, each of which was 100% diagnosable on the basis of mtDNA sequences. Forshaw and Cooper (2002) thought *chalcophus* was separable based on plumage; the other three represent nearly cryptic taxa (Chapin, 1939; Moreau, 1958b), two of which are currently paraphyletic. The precise geographic boundary between *T. schalowi* and *T. marungensis*, probably somewhere in eastern Angola or western Zambia, is not clear (Peters, 1940; Moreau, 1958b), but if the distribution given by Snow (1978) is correct, the two might actually be geographically disjunct. The distribution of genetic variance among these taxa (table 3) indicates there are four phylogenetic taxa.

*Tauraco schuettii*: The black-billed turaco occupies much of the central and eastern Congo Basin, and extends into Uganda, South Sudan, and western Kenya. We found two reciprocally monophyletic clades of haplotypes that were not sister taxa (figs. 1, 9) and explained approximately 95% of the overall genetic variation (table 3). They correspond to the traditional subspecies *T. s. schuettii* in the west and *T. s. emini* in the east (fig. 4). The forms are well marked, with violet (*schuettii*) versus green (*emini*) plumage on the back, wings, and tail (e.g., Forshaw and Cooper, 2002), and represent nonsister taxa. The suggestion in the literature of intermediates (Moreau, 1958b) or possible hybridization (Brosset and Fry, 1988) "in a relatively narrow band" (Chapin, 1939) in the northeastern Congo Basin (e.g., Schouteden, 1950) would represent secondary contact of nonsister species. It seems clear that these two taxa have been recognized as conspecifics in the past based on their shared black bill; their striking plumage differences warranted them only subspecific rank.

## PHYLOGENY

Evolutionary relationships among turacos, in the recent, quantitative phylogenetics era, have been investigated using morphological traits (Veron, 1999), karyotypes (Van Tuinen and Valentine, 1986), protein electrophoresis (Brush and Witt, 1983), and DNA sequences (Veron and Winney, 2000; Njabo and Sorenson, 2009). None of those prior studies included all the species-level taxa; additionally, the two previous DNA studies were based solely on mitochondrial sequences.

Our phylogenetic results, based on the ND2 mtDNA sequences, provide greater resolution, but are in general agreement with the results from our two nuclear loci (figs. 7, 8). In terms of generally recognized higher taxa, we obtained, for each of the three genes, monophyletic clades of go-away-birds (Criniferinae) and of green turacos (Musophaginae), plus a monotypic great blue turaco (Corythaeolinae). Veron and Winney (2000) reported similar results based on partial sequences of the mitochondrial cytochrome *b* locus for 22 taxa, as did Veron (1999) based on a cladistic analysis of 34 morphological characters for 23 species. Criniferinae and Musophaginae are also separated by two chromosomal inversions (Van Tuinen and Valentine, 1986).

The Aconitase data strongly (98% bootstrap) support *Corythaeola* as sister to the Criniferinae, while the ND2 data place it as sister to the Musophaginae with modest support (70%); the partitioned, three gene results are congruent (90%) with those of ACO1. Veron's (1999) cladistic analyses and Veron and Winney's (2000) neighbor-joining analyses placed *Corythaeola* as sister to the rest of the family; however, Njabo and Sorenson's (2009) Bayesian likelihood reanalysis of those *cyt-b* data placed *Corythaeola* as sister to the Musophaginae, albeit with very weak (0.56) support. The divergences among these three subfamily level taxa are old (perhaps 23 MYA according to Prum et al., 2015, or as much as 30–40 MYA in the dating by Njabo and Sorenson, 2009), and difficult for rapidly evolving mtDNA sequences to resolve, especially given the substantial base-composition heterogeneity we identified in that gene. The intermediate evolutionary rate of the aconitase intron, with its reduced base-composition heterogeneity, provided clearer signal (e.g., consistency index, bootstrap value).

Within the go-away-birds, our results, as well as all prior phylogenetic work, have indicated sister relationships between *Crinifer piscator* and *C. zonurus* and between *Corythaixoides personatus* and *C. concolor*. The relationships of *Criniferoides leucogaster* are not resolved: our combined analysis placed it as sister to *Crinifer* with moderate (78%) bootstrap support; Njabo and Sorenson (2009) placed it as sister to *Crinifer* and *Corythaixoides* with a weak Bayesian posterior of 0.83. Thus, the precise branching pattern within the Criniferinae remains uncertain.

Within the green turaco (Musophaginae) clade, the major differences between our phylogenetic results and much of the more recent work reflect our addition of Prince Ruspoli's turaco to the study, our addition of taxa previously treated as subspecies, and our much-improved sampling of individuals and populations. For the ND2 sequences, we found five major clades of these birds with bootstrap support of 98% to 100%; each of the five clades were many substitutions apart in the ND2 haplotype network of turacos (fig. 1).

A branch arising from the first node within the green turacos led to a clade comprised of members of the genus *Gallirex* (sensu Dickinson and Remsen, 2013). All recent authors have recognized a close relationship among these birds, although *G. johnstoni* and *G. kivuensis* were often placed in the genus *Ruwenzorornis* (table 1). Snow (1978) treated *Gallirex* and *Ruwenzorornis* as a superspecies, as did subsequent accounts such as those of Brosset and Fry (1988) and Forshaw and Cooper (2002). That the *Gallirex* (including *Ruwenzorornis*) complex is sister to the remaining green turacos was reported by Veron and Winney (2000) and confirmed by Njabo and Sorenson (2009).



The ND2 and aconitase genes both identified a second turaco clade comprised of *leucotis*, *donaldsoni*, and *ruspolii*. The prior mtDNA studies of Veron and Winney (2000) and Njabo and Sorenson (2009) included only *leucotis* (sensu stricto); the latter's Bayesian analysis placed *leucotis* in a position equivalent to our result for the clade of three taxa. None of the previous DNA studies included *ruspolii*; we placed it in the *leucotis* clade with high (100%) mitochondrial and combined bootstraps. Brosset and Fry (1988) thought *hartlaubi* was related to this assemblage and allied it with *leucotis* and *ruspolii* in a superspecies; our data strongly reject that hypothesis.

The third clade was comprised of two species, *rossae* and *violacea*, traditionally placed in the genus *Musophaga*, plus the *macrorhyncha* complex. The previous sequencing studies both identified this clade. Brosset and Fry (1988) thought there was a close relationship between the first two species, traditional *Musophaga*, and our first clade, the *Gallirex* complex; they based this treatment on plumage pattern and color, and on the cytological results of Van Tuinen and Valentine (1986). However, this latter justification was not supported by those karyotypic results; it represented a misinterpretation of symplesiomorphy as evidence for close relationship.

Our fourth clade, consisting of *bannermani*, *erythrolophus*, and *leucolophus*, present in all three genetic loci, was also identified by Njabo and Sorenson (2009). Traditional classifications (e.g., Brosset and Fry, 1988) have treated *bannermani* and *erythrolophus* as members of a superspecies; the autapomorphic plumage traits of *leucolophus* apparently masked its close relationship with the other two species. For example, Veron (1999) did not recover this clade in his cladistic analysis of 34 plumage and other morphological characters.

The final, largest, clade of green turacos was also identified in the other two molecular studies. However, because of our broad sampling, the clade here includes more species-level taxa than in those prior results. Additionally, the phylogeographic results indicate that some taxa formerly treated as conspecific (e.g., Dickinson and Remsen, 2013) are not even monophyletic: for example, *T. schuettii* and *T. emini*, and *T. livingstonii* and *T. reichenowi*. In addition, each of the superspecies assemblages recognized by Snow (1978) within these birds was either para- or polyphyletic. One genetically well-differentiated taxon, *T. chalcophus*, was not even recognized as a valid subspecies by Turner (1997) or Dickinson and Remsen (2013), and many taxa that were 100% diagnosable based on the sequences and morphology were not recognized. As is apparent from the phylogeographic network (fig. 1), the green turaco clade represents a rapid, probably recent series of speciation events.

#### CLASSIFICATION

As pointed out above, our phylogeographic results require the recognition of species-level taxa of turacos not afforded that rank in recent classifications of the family (Brosset and Fry, 1988; Turner, 1997; Dickinson and Remsen, 2013). In addition, our results indicate that the genus *Tauraco* is not monophyletic in the first two of those classifications, and that several superspecies complexes recognized by Moreau (1958a), Snow (1978), Brosset and Fry (1988), Short et al. (1990), Sibley and Monroe (1990) and Turner (1997) are not monophyletic (table

4). The application of the biological species concept, and the subsequent allocation of such species to superspecies, has consistently obscured evolutionary relationships in this family of birds, even by authors (e.g., Short et al., 1990) who have themselves pointed out the danger of overreaching superspecific taxa (Amadon and Short, 1992). Although the failure to recognize nearly cryptic species and the recognition of polyphyletic species is understandable given the similarity of plumages in the green turacos, the recognition of polyphyletic superspecies represents an active error of using parapatry or of weighting some characters more highly than others in the absence of any phylogenetic analysis. Fry (1988) recognized this as a potential issue in this group. As a consequence of all these problems, we propose a classification that corrects the errors and provides a list of the taxa that would be essential for any study of evolution or biogeography of these birds or for a larger investigation of patterns of historical diversification on the African continent.

We recognize three subfamilies of musophagids: Corythaeolinae, Criniferinae, and Musophaginae. Recent classifications have varied in recognizing between two (e.g., Sibley and Monroe, 1990) and four (e.g., Verheyen, 1956) subfamilies; however, most have used three (Turner, 1997). Bock (1994) pointed out that Tauracidae and Tauracinae (Verheyen, 1956), originally Turacidae (Rafinesque, 1815), have priority over Musophagidae (Lesson, 1828), but Musophagidae has been used consistently as a family-group name for over 150 years.

There has been a long history of tension between lumping and splitting at the generic level. However, as Mayr (1943) pointed out, in a Linnaean classification the scientific name of a species consists of generic and specific designations; these are intended to represent alternate aspects of relationship: the specific epithet emphasizes differences and individuates the species, whereas the generic allocation is a collective and should carry information about similarity among species. The balance between the two in a classification is a matter of convenience and opinion. As the ratio of genera to species in a classification approaches one, the generic name becomes redundant—all the information content is in the species epithet; as the ratio of genera to species gets small, hierarchical content of the classification is lost.

Although von Boetticher (1947) used four genera for the five species of go-away-birds, most recent classifications have used three (e.g., Dickinson and Remsen, 2013). Nevertheless, with an average of only 1.67 species each, such genera are almost redundant in a Latin binomial. A more efficient classification would use a single genus; *Crinifer* has priority. We also note that in our maximum likelihood tree based on complete ND2 sequences (not shown), the divergences among the five go-away-birds are of the same magnitude as those among species within our genera *Gallirex* and *Musophaga*, and much less than among our proposed genera in the Musophaginae.

Within the green turacos, there were five major clades (e.g., fig. 1) identified by ND2 that were either concordant or consistent with the nuclear loci (fig. 7, fig. 8). Because species traditionally placed in the genus *Tauraco* were found in four of these, one must either recognize a very large genus *Tauraco* that includes at least 23 species, including *Musophaga* (as did Veron and Winney, 2000), or allocate traditional members of *Tauraco* to other genera. The former, a classification with two genera comprised of 4 and 23 species, seems unbalanced. Alternatively,

TABLE 4. Phylogenetic status of musophagine superspecies.

Superspecies group	Authors recognizing superspecific taxon <sup>a</sup>	Phylogenetic status
<i>porphyreolophus</i> + <i>chlorochlamys</i> + <i>johnstoni</i> + <i>kivuensis</i>	M58; S78; BF88; SM90	Monophyletic
<i>violacea</i> + <i>rossae</i>	S78; BF88; SHM90; SM90; T97	Monophyletic
<i>leucotis</i> + <i>donaldsoni</i> + <i>ruspolii</i> + <i>hartlaubi</i>	M58; S78; BF88; SHM90; SM90	Polyphyletic
<i>leucotis</i> + <i>donaldsoni</i> + <i>hartlaubi</i>	T97	Polyphyletic
<i>erythrolophus</i> + <i>bannermani</i>	M58; S78; BF88; SM90; T97	Paraphyletic
<i>persa</i> + <i>buffoni</i> + <i>chalcopholus</i> + <i>corythaix</i> + <i>emini</i> + <i>fischeri</i> + <i>livingstonii</i> + <i>loitanus</i> + <i>marungensis</i> + <i>reichenowi</i> + <i>schalowi</i> + <i>schuettii</i>	S78; BF88; SHM90; SM90; T97	Paraphyletic

<sup>a</sup> Moreau, 1958b (M58); Snow, 1978 (S78); Brosset and Fry, 1988 (BF88); Short et al., 1990 (SHM90); Sibley and Monroe, 1990 (SM90); Turner, 1997 (T97).

von Boetticher (1947) recognized 13 genera and subgenera for his 17 species, a ratio of 1.3 species per generic-level taxon. We recognize five genera with an average of approximately five species per genus (and a range of three to 13). Names are already available for each of these.

In several cases in which we have elevated taxa to the species rank, English common names were not available in the literature. Where appropriate, we have added geographic modifiers, such as eastern and western or northern and southern, to the current vernaculars. In other cases, we have suggested the use of modifiers based on relevant geographical or political names.

#### FAMILY MUSOPHAGIDAE Lesson, 1828

##### SUBFAMILY CORYTHAEOLINAE Verheyen, 1956 – blue turacos

Genus *CORYTHAEOLA* Heine, 1860

*Corythaeola cristata* (Vieillot, 1816) GREAT BLUE TURACO

##### SUBFAMILY CRINIFERINAE Verheyen, 1956 – go-away-birds

Genus *CRINIFER* Jarocki, 1821

*Crinifer leucogaster* (Rüppell, 1842a) WHITE-BELLIED GO-AWAY-BIRD

*Crinifer piscator* (Boddaert, 1783) WESTERN GREY PLANTAIN-EATER

*Crinifer zonurus* (Rüppell, 1835a) EASTERN GREY PLANTAIN-EATER

*Crinifer concolor* (Smith, 1833) GREY GO-AWAY-BIRD

*Crinifer personatus* (Rüppell, 1842b) BARE-FACED GO-AWAY-BIRD

##### SUBFAMILY MUSOPHAGINAE (Lesson, 1828) – turacos

Genus *GALLIREX* Lesson, 1844

*Gallirex porphyreolophus* (Vigors, 1831) SOUTHERN PURPLE-CRESTED TURACO

*Gallirex chlorochlamys* Shelley, 1881 NORTHERN PURPLE-CRESTED TURACO

*Gallirex johnstoni* Sharpe, 1901 RWENZORI TURACO

*Gallirex kivuensis* (Neumann, 1908a) KIVU TURACO

Genus *MENELIKORNIS* von Boetticher, 1947

*Menelikornis leucotis* (Rüppell, 1835b) WHITE-CHEEKED TURACO

*Menelikornis donaldsoni* (Sharpe, 1895) DONALDSON'S TURACO



- Menelikornis ruspolii* (Salvadori, 1896) PRINCE RUSPOLI'S TURACO  
 Genus *MUSOPHAGA* Isert, 1789
- Musophaga rossae* Gould, 1852 LADY ROSS'S TURACO
- Musophaga violacea* Isert, 1789 VIOLET TURACO
- Musophaga macrorhyncha* (Fraser, 1839) WESTERN YELLOW-BILLED TURACO
- Musophaga verreauxii* Schlegel, 1854 EASTERN YELLOW-BILLED TURACO  
 Genus *PROTURACUS* Bates, 1923
- Proturacus bannermani* Bates, 1923 BANNERMAN'S TURACO
- Proturacus leucolophus* (von Heuglin, 1855) WHITE-CRESTED TURACO
- Proturacus erythrolophus* (Vieillot, 1819a) RED-CRESTED TURACO  
 Genus *TAURACO* Kluk, 1779
- Tauraco persa* (Linnaeus, 1758) EASTERN GREEN TURACO
- Tauraco buffoni* (Vieillot, 1819b) WESTERN GREEN TURACO
- Tauraco emini* (Reichenow, 1893) EASTERN BLACK-BILLED TURACO
- Tauraco hartlaubi* (Fischer and Reichenow, 1884) HARTLAUB'S TURACO
- Tauraco fischeri* (Reichenow, 1878) FISCHER'S TURACO
- Tauraco reichenowi* (Fischer, 1880) REICHENOW'S TURACO
- Tauraco corythaix* (Wagler, 1827) KNYSNA TURACO
- Tauraco livingstonii* (Gray, 1864) LIVINGSTONE'S TURACO
- Tauraco schuettii* (Cabanis, 1879) WESTERN BLACK-BILLED TURACO
- Tauraco chalcophus* (Neumann, 1895) NGORONGORO TURACO
- Tauraco schalowi* (Reichenow, 1891) SCHALOW'S TURACO
- Tauraco loitanus* (Neumann, 1908b) LOITA TURACO
- Tauraco marungensis* (Reichenow, 1902) ZAMBIA TURACO

#### BIOGEOGRAPHY

Nearly a century ago, Chapin (1923) published a map summarizing general avian distribution patterns across Africa; he recognized six ecological provinces and 17 districts, largely based on vegetation, which he thought reflected overall faunal diversity. Moreau (1966) provided a more detailed update of such patterns in his monograph on the African avifauna, but it was not until the compendia of Hall and Moreau (1970) and Snow (1978) that detailed distribution maps of most species-level taxa of African birds were assembled. Crowe and Crowe (1982) analyzed those data in a statistical assessment of the efficacy of vegetation as a surrogate for defining avifaunal zones and boundaries, and provided a hierarchical classification of such zones. Dowsett-Lemaire and Dowsett (2001) and de Klerk et al. (2002) reexamined those patterns in greater detail. More recently, Linder et al. (2012) summarized African biogeographic patterns across plants and vertebrates. Of course, most of those analyses were based on assessments of species limits prevalent at the time, before detailed molecular studies were available. Our phylogeographic results suggest there is substantially more diversity and genetic structure at varying geographic scales than prior

authors had suspected. This represents an additional example of a pattern that has been suggested to be general across birds (Barrowclough et al., 2016).

The importance of montane regions of Africa as centers of diversity is widely recognized (Stuart et al., 1993; Burgess et al., 2007; Fjeldså and Bowie, 2008). Dowsett (1986) summarized the organization of the montane avifaunal regions of Africa and these are generally concordant with our clades (fig. 1) of montane turacos. However, with the exception of Bannerman's turaco, we observed significant taxonomic and geographic structure within his montane groups (e.g., *Gallirex johnstoni*, *Tauraco hartlaubi*); that is, phylogeography revealed finer geographic structure, presumably due to more recent historical events, than Dowsett (1986) identified using biological species as units of history. Multiple recent phylogeographic studies are consistent with this pattern of cryptic diversity within assemblages of African montane birds (e.g., Bowie et al., 2004, 2006, 2009). Voelker et al. (2010b) suggested that these montane patterns were driven by Pliocene forest dynamics.

There have been few avian phylogeographic surveys at the larger spatial scale of the extensive African lowland forest; this is perhaps due to the difficulty of obtaining fresh DNA samples from multiple political entities. Nevertheless, our results are generally consistent with those of several recent studies in uncovering significant geographic diversity within lowland avian species and subspecies (e.g., Marks, 2010; Fuchs et al., 2016; Huntley and Voelker, 2016). For example, in West Africa, in two lowland forest-associated traditional complexes, those of *M. macrorhyncha* and *T. persa*, we found strong genetic differentiation across or near the Dahomey Gap. The concordance of avian divergence across the Dahomey Gap/lower Niger River is a well-known pattern (e.g., Fuchs and Bowie, 2015) and corresponds to a gap between probable forest refuges (e.g., Diamond and Hamilton, 1980; Mayr and O'Hara, 1986; Maley, 2001). On the other hand, in the more northerly distributed, savannah-associated *M. violacea*, divergence across the region was not observed. Similarly, in *P. leucolophus*, distributed in dry forest and savannah north of the Congo Basin, we observed no pronounced geographic structure, but in the forest-dwelling *T. schalowi* complex, we observed substantial geographic structure. Thus, our results indicate the possible existence, both within montane and lowland forest avifaunas, of largely unappreciated diversity in many taxa. Parallel surveys and attendant discoveries have already begun on the mammalian fauna (e.g., Moodley and Bruford, 2007; Anco et al., 2017).

Perhaps the most interesting of our geographic observations were those of taxa with marked genetic breaks in locations not associated with major phenotypic divergence or current habitat discontinuities. *Tauraco schalowi*/*T. marungensis* and *T. schuettii*/*T. emini* appear to be parapatric, or possibly even allopatric, somewhere in the eastern or central Congo River Basin; this may be the result of past habitat fragmentation in the eastern Congo during the last (*schalowi*/*marungensis*) or an earlier (*schuettii*/*emini*) glacial cycle (e.g., Maley, 2001). Similarly, *Gallirex porphyreolophus*/*G. chlorochlamys* and *T. livingstonii*/*T. reichenowi* (the latter not a species pair) are differentiated in forested habitat in coastal eastern Africa; Fuchs et al. (2017) found mixed haplotype clades in some drongos in this same region. Future, denser sampling will be required to better characterize those zones.

## FURTHER RESEARCH

Not surprisingly, given the geographical heterogeneity of specimen collecting in sub-Saharan Africa, a great many problems remain in our understanding of turaco systematics. Perhaps the real import of our research is the discovery of how much remains to be investigated concerning geographic variation and species limits in turacos. First, we have yet to obtain DNA sequences for two potentially important populations, originally described as subspecies, that may represent differentiated taxa. These are the population of *T. persa* at the east-central portion of its range (*T. p. zenkeri*), and the population of *Gallirex johnstoni* on Mt. Kabobo in the eastern Democratic Republic of Congo (*G. j. bredoi*). In addition, the taxonomic status of the population of *T. fischeri* on Zanzibar is enigmatic and requires further attention. Second, our geographic sampling of green turacos has left large portions of the ranges of several of the species unsampled (e.g., *Tauraco schalowi*, *P. leucolophus*, and *M. rossae*). The *T. hartlaubi* complex probably harbors several additional species-level taxa and requires additional, especially nuclear, sequencing. In other cases, further sampling might allow for the quantitative characterization of possible zones of contact between sister taxa across western Africa (e.g., *T. persa* and *T. buffoni*) and zones of contact between sister taxa, such as *T. corythaix* and *T. livingstonii* in southern Africa and *Menelikornis leucotis* and *M. donaldsoni* in Ethiopia (Erard and Prévost, 1971). Distantly related pairs, such as *T. livingstonii* and *T. reichenowi* in eastern Africa, as well as *Tauraco schalowi* and *T. marungensis*, and *T. schuettii* and *T. emini*, both in the Congo Basin, all require attention to establish range limits. The *Gallirex porphyreolophus* plus *G. chlorochlamys* complex in Zambia, Zimbabwe, and Mozambique particularly requires attention. Third, thorough geographic surveys of the great blue turaco (*Corythaeola*) and of the go-away-birds (*Crinifer*) are necessary.

Finally, all our phylogeographic analysis has been based on mitochondrial DNA sequences. Although mtDNA is expected to provide a more sensitive indicator of recent geographical isolation than is nuclear DNA (Zink and Barrowclough, 2008), apparent instances of mitochondrial-nuclear discordance are known in birds (Toews and Brelsford, 2012). A multilocus nuclear DNA survey of turaco phylogeography would be welcome.

## ACKNOWLEDGMENTS

We thank Jonas Lai and Bill Mauck for assistance with lab work associated with this research. Curators and collection managers at the British Museum (Natural History) at Tring (Mark Adams and Robert Prys-Jones), the Burke Museum of the University of Washington (Sharon Birks and John Klicka), the Field Museum of Natural History (John Bates, Dave Willard, and Ben Marks), the University of Kansas Biodiversity Institute (Rob Moyle and Mark Robbins), the Yale Peabody Museum (Rick Prum and Kristof Zyskowski), and the Zoological Museum of the University of Copenhagen (Jon Fjeldså and Jan Kristensen) generously provided data and tissue and toe pad samples for our DNA sequencing; Paul Sweet and Tom Trombone assisted with those efforts. Mary LeCroy offered critical assistance with tracing the nomenclatural history of the Musophagidae; she and Tom Trombone helped identify obscure African localities. Gary Voelker, Rauri Bowie, and several anonymous reviewers offered useful

comments on preliminary versions of the manuscript. Lab expenses for this research were provided by the Sackler Institute for Comparative Genomics, the Ambrose Monell Laboratory, and the Cullman Program for Molecular Systematics. Utku Perктаş was a Frank M. Chapman postdoctoral fellow at the American Museum of Natural History when this research was begun; Helen Hays generously assisted with his support and logistics in New York.

## REFERENCES

- Amadon, D., and L.L. Short. 1992. Taxonomy of lower categories—suggested guidelines. *Bulletin of the British Ornithologists Club* 112A: 11–38.
- Anco, C., et al. 2017. Historical mitochondrial diversity in African leopards (*Panthera pardus*) revealed by archival museum specimens. *Mitochondrial DNA*. [doi.org/10.1080/24701394.2017.1307973]
- Barrowclough, G.F., J.G. Groth, and L.A. Mertz. 2006. The RAG-1 exon in the avian order Caprimuliformes: phylogeny, heterozygosity, and base composition. *Molecular Phylogenetics and Evolution* 41: 238–248.
- Barrowclough, G.F., J.G. Groth, K.J. Odom, and J.E. Lai. 2011. Phylogeography of the barred owl (*Strix varia*): species limits, multiple refugia, and range expansion. *Auk* 128: 696–706.
- Barrowclough, G.F., J. Cracraft, J. Klicka, and R.M. Zink. 2016. How many kinds of birds are there and why does it matter? *Plos One* 11: e0166307.
- Bates, G.L. 1923. *Proturacus bannermani*, gen. et. sp. nov. *Bulletin of the British Ornithologists' Club* 43: 140–141.
- Bock, W.J. 1994. History and nomenclature of avian family-group names. *Bulletin of the American Museum of Natural History* 222: 1–281.
- Boddaert, P. 1783. *Falco piscator*. In *Table des planches enluminées d'histoire naturelle de M. d'Aubenton*: 28. Utrecht: privately printed.
- Bowie, R.C.K., J. Fjeldså, S.J. Hackett, and T.M. Crowe. 2004. Systematics and biogeography of double-collared sunbirds from the Eastern Arc Mountains, Tanzania. *Auk* 121: 660–681.
- Bowie, R.C.K., J. Fjeldså, S.J. Hackett, J.M. Bates, and T.M. Crowe. 2006. Coalescent models reveal the relative roles of ancestral polymorphism, vicariance, and dispersal in shaping phylogeographical structure of an African montane forest robin. *Molecular Phylogenetics and Evolution* 38: 171–188.
- Bowie, R.C.K., J. Fjeldså, and J. Kiure. 2009. Multilocus molecular DNA variation in Winifred's warbler *Scepomycter winifredae* suggests cryptic speciation and the existence of a threatened species in the Rubeho-Ukaguru Mountains of Tanzania. *Ibis* 151: 709–719.
- Brosset, A., and C.H. Fry. 1988. Order Musophagiformes. In C.H. Fry, S. Keith, and E.K. Urban (editors), *The birds of Africa*. Vol. III: 26–57. San Diego: Academic Press.
- Brush, A.H., and H.-H. Witt. 1983. Intraordinal relationships of the Pelecaniformes and Cuculiformes: electrophoresis of feather keratins. *Ibis* 125: 181–199.
- Burgess, N.D., et al. 2007. The biological importance of the Eastern Arc Mountains of Tanzania and Kenya. *Biological Conservation* 134: 209–231.
- Cabanis, J. 1879. *Corythaix schüttii*. *Ornithologisches Centralblatt* 4: 180.
- Carlson, L.M., et al. 1991. Selective expression of RAG-2 in chicken B cells undergoing immunoglobulin gene conversion. *Cell* 64: 201–208.
- Chapin, J.P. 1923. Ecological aspects of bird distribution in tropical Africa. *American Naturalist* 57: 106–125.

- Chapin, J.P. 1939. The birds of the Belgian Congo. Part 2. *Bulletin of the American Museum of Natural History* 75: 1–632.
- Chapin, J.P. 1963. The touracos: an African bird family. *Living Bird* 2: 56–68.
- Clancey, P.A. 1971. A handlist of the birds of southern Moçambique. *Instituto de Investigação Científica de Moçambique (série A)* 10: 145–303.
- Collar, N.J. 2018. Taxonomy as tyranny. *Ibis* 160: 481–484.
- Crowe, T.M., and A.A. Crowe. 1982. Patterns of distribution, diversity and endemism in Afrotropical birds. *Journal of Zoology, London* 198: 417–442.
- de Klerk, H.M., T.M. Crowe, J. Fjeldså, and N.D. Burgess. 2002. Patterns of species richness and narrow endemism of terrestrial bird species in the Afrotropical region. *Journal of Zoology, London* 256: 327–342.
- Desjardins, P., and R. Morais. 1990. Sequence and gene organization of the chicken mitochondrial genome: a novel gene order in higher vertebrates. *Journal of Molecular Biology* 212: 599–634.
- Diamond, A.W., and A.C. Hamilton. 1980. The distribution of forest passerine birds and Quaternary climatic change in tropical Africa. *Journal of Zoology, London* 191: 379–402.
- Dickinson, E.C., and J.V. Remsen, Jr. (editors). 2013. The Howard and Moore complete checklist of the birds of the world, 4th ed., vol. 1, Non-passerines. Eastbourne: Aves Press.
- Dowsett, R.J. 1986. Origins of the high-altitude avifaunas of tropical Africa. *In* F. Vuilleumier and M. Monasterio (editors), *High altitude tropical biogeography*: 557–585. New York: Oxford University Press.
- Dowsett-Lemaire, F., and R.J. Dowsett. 2001. African forest birds: patterns of endemism and species richness. *In* W. Weber, L.J.T. White, A. Vedder, and L. Naughton-Treves (editors), *African rain forest ecology and conservation: an interdisciplinary perspective*: 233–262. New Haven: Yale University Press.
- Erard, C., and J. Prévost. 1971. Notes on some Ethiopian birds. *Bulletin of the British Ornithologists' Club* 91: 21–25.
- Excoffier, L., G. Laval, and S. Schneider. 2005. ARLEQUIN ver. 3.0: an integrated software package for population genetics data analysis. *Evolutionary Bioinformatics Online* 1: 47–50.
- Field, D.J., and A.Y. Hsiang. 2018. A North American stem turaco, and the complex biogeographic history of modern birds. *BMC Evolutionary Biology* 18: 102. [doi.org/10.1186/s12862-018-1212-3]
- Fischer, G.A. 1880. Ein neuer Helmkekukuk aus Ost-Afrika. *Ornithologische Centralblatt* 5: 174.
- Fischer, A.G., and A. Reichenow. 1884. Neue Vogelarten aus dem Massailand (Inneres Ostafrika). *Journal für Ornithologie* 32: 52–58.
- Fjeldså, J., and R.C.K. Bowie. 2008. New perspectives on the origin and diversification of Africa's forest avifauna. *African Journal of Ecology* 46: 235–247.
- Forshaw, J.M., and W.T. Cooper. 2002. *Turacos: a natural history of the Musophagidae*. Melbourne: Nokomis Editions.
- Fraser, L. 1839. *Corythaix macrorhynchus*. *Proceedings of the Zoological Society of London* 7: 34–35.
- Fry, C.H. 1988. Speciation patterns in eight orders of Afrotropical land birds. *In* *Acta XIX Congressus Internationalis Ornithologici*, vol. 2: 2528–2535. Ottawa: National Museum of Natural Sciences.
- Fuchs, J., and R.C.K. Bowie. 2015. Concordant genetic structure in two species of woodpecker distributed across the primary West African biogeographic barriers. *Molecular Phylogenetics and Evolution* 88: 64–74.
- Fuchs, J., J. Fjeldså, and R.C.K. Bowie. 2017. Diversification across major biogeographic breaks in the African Shining/Square-tailed Drongos complex (Passeriformes: Dicruridae). *Zoologica Scripta* 46: 27–41.



- Goldstein, P.Z., R. DeSalle, G. Amato, and A.P. Vogler. 2000. Conservation genetics at the species boundary. *Conservation Biology* 14: 120–131.
- Gould, J. 1852 (“1851”). On a new species of *Musophaga*. *Proceedings of the Zoological Society of London* p. 93.
- Gray, G.R. 1864. Notice of a new species of *Turacus* from Eastern Africa. *Proceedings of the Zoological Society of London*: 44–45.
- Groth, J.G., and G.F. Barrowclough. 1999. Basal divergences in birds and the phylogenetic utility of the nuclear RAG-1 gene. *Molecular Phylogenetics and Evolution* 12: 115–123.
- Groth, J.G., I. Arbisser, N.H. Landman, and G.F. Barrowclough. 2015. The mitochondrial genome of *Allonautilus* (Mollusca: Cephalopoda): base composition, noncoding-region variation, and phylogenetic divergence. *American Museum Novitates* 3834: 1–13.
- Hackett, S.J., et al. 2008. A phylogenomic study of birds reveals their evolutionary history. *Science* 320: 1763–1768.
- Hall, B.P., and R.E. Moreau. 1970. An atlas of speciation in African passerine birds. London: British Museum (Natural History).
- Heine, J.G.F. 1860. *Corythaëola*. *Journal für Ornithologie* 8: 190.
- Holsinger, K.E., and R.J. Mason-Gamer. 1996. Hierarchical analysis of nucleotide diversity in geographically structured populations. *Genetics* 142: 629–639.
- Huntley, J.W., and G. Voelker. 2016. Cryptic diversity in Afro-tropical lowland forests: the systematics and biogeography of the avian genus *Bleda*. *Molecular Phylogenetics and Evolution* 99:297–308.
- Isert, P.E. 1789. Kurze Beschreibung und Abbildung einigen Vögel aus Guinea. *Schriften der Gesellschaft Naturforschender Freunde zu Berlin. Beobachtungen und Entdeckungen aus der Naturkunde* 3: 16–20.
- Jarocki, F.P. 1821. *Zoologia czyli zwierzetopismo ogólne podług naynowszeo systemu ulozone*. Warsaw: Drukarnia Latkiewicza.
- Jarvis, E.D., et al. 2014. Whole-genome analyses resolve early branches in the tree of life of modern birds. *Science* 346: 1320–1331.
- Kluk, K. 1779. *Tauraco*. *Historia naturalna*. Warsaw: Drukarni J. K. Mości i Rzeczypospolitey, u XX. Scholarum Piarum.
- Krajewski, C., J.T. Sipiorski, and F.E. Anderson. 2010. Complete mitochondrial genome sequences and the phylogeny of cranes. *Auk* 127: 440–452.
- Lack, D. 1971. *Ecological isolation in birds*. Cambridge: Harvard University Press.
- Lesson, R.P. 1828. VIIe famille. Les Musophagées. *In Manuel d'ornithologie, ou description des genres et des principales espèces d'oiseaux*, vol. 2: 153–157. Paris: Roret.
- Lesson, R.P. 1844. Catalogue des oiseaux nouveaux ou peu connus de la collection Abeillé. *L'Echo du Monde Savant* 11: 110–112.
- Linder, H.P., et al. 2012. The partitioning of Africa: statistically defined biogeographical regions in sub-Saharan Africa. *Journal of Biogeography* 39: 1189–1205.
- Linnaeus, C. 1758. 52. Cuculus. *In Systema naturae per regna tria naturae, secundum classes, ordines, genera, species, cum characteribus, differentiis, synonymis, locis*. 10th ed., tomus 1: 110–112. Holmiae [Stockholm]: Laurentii Salvii.
- Livingstone, D.A. 1975. Late Quaternary climate change in Africa. *Annual Review of Ecology and Systematics* 6: 249–280.
- Maley, J. 2001. The impact of arid phases on the African rain forest through geological history. *In W. Weber, L.J.T. White, A. Vedder, and L. Naughton-Treves (editors), African rain forest ecology and conservation: an interdisciplinary perspective*: 68–87. New Haven: Yale University Press.

- Marks, B.D. 2010. Are lowland rainforests really evolutionary museums? Phylogeography of the green hylia (*Hylia prasina*) in the Afrotropics. *Molecular Phylogenetics and Evolution* 55: 178–184.
- Mayr, E. 1943. Criteria of subspecies, species and genera in ornithology. *Annals of the New York Academy of Sciences* 44: 133–139.
- Mayr, E. 1982. *The growth of biological thought*. Cambridge: Harvard University Press.
- Mayr, E., and R.J. O'Hara. 1986. The biogeographic evidence supporting the Pleistocene forest refuge hypothesis. *Evolution* 40: 55–67.
- Moodley, Y., and M.W. Bruford. 2007. Molecular biogeography: towards an integrated framework for conserving Pan-African biodiversity. *Plos One* 2: e0000454.
- Moreau, R.E. 1958a. Some aspects of the Musophagidae, Part 1. *Ibis* 100: 67–82.
- Moreau, R.E. 1958b. Some aspects of the Musophagidae, Part 2. *Ibis* 100: 83–112.
- Moreau, R.E. 1958c. Some aspects of the Musophagidae, Part 3. *Ibis* 100: 238–270.
- Moreau, R.E. 1959. The classification of the Musophagidae. In A.J. Cain (editor), *Function and taxonomic importance*: 113–119. London: Systematics Association.
- Moreau, R.E. 1966. *The bird faunas of Africa and its islands*. New York: Academic Press.
- Nei, M. 1987. *Molecular evolutionary genetics*. New York: Columbia University Press.
- Neumann, O. 1895. *Turacus chalcophus*. *Ornithologische Monatsberichte* 3: 87.
- Neumann, O. 1908a. *Ruwenzorornis jonhstoni* [sic] *kivuensis*, subsp. n. *Bulletin of the British Ornithologists' Club* 21: 54.
- Neumann, O. 1908b. Notes on African birds in the Tring museum. *Novitates Zoologicae* 15: 366–390.
- Njabo, K.Y., and M.D. Sorenson. 2009. Origin of Bannerman's turaco *Tauraco bannermani* in relation to historical climate change and the distribution of West African montane forests. *Ostrich* 80: 1–7.
- Outlaw, R.K., G. Voelker, and R.C.K. Bowie. 2010. Shall we chat? Evolutionary relationships in the genus *Cercomela* (Muscicapidae) and its relation to *Oenanthe* reveals extensive polyphyly among chats distributed in Africa, India and the Palearctic. *Molecular Phylogenetics and Evolution* 55: 284–292.
- Pakenham, R.H.W. 1938. *Turacus fischeri zanzibaricus*, subsp. nov. *Bulletin of the British Ornithologists' Club* 58: 111–112.
- Perktaş, U., G.F. Barrowclough, and J.G. Groth. 2011. Phylogeography and species limits in the green woodpecker complex (Aves: Picidae): multiple Pleistocene refugia and range expansion across Europe and the Near East. *Biological Journal of the Linnean Society* 104: 710–723.
- Peters, J.L. 1940. *Check-list of birds of the world*, vol. 4. Cambridge: Harvard University Press.
- Peterson, A.T., and A.G. Navarro-Sigüenza. 1999. Alternate species concepts as bases for determining priority conservation area. *Conservation Biology* 13: 427–431.
- Posada, D., and K.A. Crandall. 1998. MODELTEST: testing the model of DNA substitution. *Bioinformatics* 14: 817–818.
- Prum, R.O., et al. 2015. A comprehensive phylogeny of birds (Aves) using targeted next-generation DNA sequencing. *Nature* 526: 569–573.
- Rafinesque, C.S. 1815. *Analyse de la nature, ou tableau de l'univers et des corps organisés*. Palermo, Sicily: privately printed.
- Reddy, S. 2008. Systematics and biogeography of the shrike-babblers (*Pteruthius*): species limits, molecular phylogenetics, and diversification patterns across southern Asia. *Molecular Phylogenetics and Evolution* 47: 54–72.
- Reichenow, A. 1878. *Corythaix fischeri* Rchw. n. sp. *Ornithologische Centralblatt* 3: 87–88.
- Reichenow, A. 1891. Uebersicht der von Dr. Emin Pascha auf seiner Reise von Bagamojo bis Tabora gesammelten Vögel. *Journal für Ornithologie* 39: 139–164.

- Reichenow, A. 1893. Diagnosen neuer Vogelarten aus Central-Afrika. Ornithologische Monatsberichte 1: 29–32.
- Reichenow, A. 1902. 607. *Turacus schalowi* (Rchw.). In Die Vögel Afrikas, vol. 2: 51–53. Neudamm: J. Neumann.
- Rüppell, E. 1835a. *Chizaerhis zonurus*. In Neue wirbelthiere der Fauna von Abyssinien gehörig. Vögel. 9–10. Frankfurt: S. Schmerber.
- Rüppell, E. 1835b. *Corythaix leucotis*. In Neue Wirbelthiere der Fauna von Abyssinien gehörig, Vögel. 8–9. Frankfurt: S. Schmerber.
- Rüppell, E. 1842a. *Chizaerhis leucogaster*. Proceedings of the Zoological Society of London: 9.
- Rüppell, E. 1842b. *Chizaerhis personata*. Proceedings of the Zoological Society of London: 8–9.
- Salvadori, T. 1896. Uccelli raccolti da Don Eugenio dei Principi Ruspoli. Annali del Museo Civico di Storia Naturale di Genova 36:43–46.
- Schlegel, H. 1854. Vorläufige notiz über die wahre *Musophaga persa*. Journal für Ornithologie 2: 462–463.
- Schouteden, H. 1950. De vogels van Belgisch Congo en van Ruanda-Urundi. Vol. 1. Annalen van het Museum van Belgisch Congo C.-Dierkunde (Series 4) 2: 1–564.
- Sharpe, B. 1895. *Turacus donaldsoni*, sp. n. Bulletin of the British Ornithologists' Club 4: 32.
- Sharpe, B. 1901. *Gallirex johnstoni*, n. sp. Bulletin of the British Ornithologists' Club 11: 57.
- Shelley, G. 1881. On new species of East-African birds. Ibis (ser. 4) 5: 115–118.
- Short, L.L., J.F.M. Horne, and C. Muringo-Gichuki. 1990. Annotated check-list of the birds of East Africa. Proceedings of the Western Foundation of Vertebrate Zoology 4: 61–246.
- Sibley, C.G., and J.E. Ahlquist. 1990. Phylogeny and classification of birds. New Haven: Yale University Press.
- Sibley, C.G., and B.L. Monroe, Jr. 1990. Distribution and taxonomy of birds of the world. New Haven: Yale University Press.
- Slatkin, M. 1991. Inbreeding coefficients and coalescence times. Genetical Research 58: 167–175.
- Smith, A. 1833. Proceedings of the South African literary and scientific institution. South African Quarterly Journal (2nd series) 1: 48.
- Smithers, R.H.N. 1951. Some interesting Rhodesian records. Ostrich 22: 156–162.
- Snow, D.W., (editor). 1978. An atlas of speciation in African non-passerine birds. London: British Museum (Natural History).
- Stuart, S.N., F.P. Jensen, S. Brøgger-Jensen, and R.I. Miller. 1993. The zoogeography of the montane forest avifauna of eastern Tanzania. In J.C. Lovett and S.K. Wasser (editors), Biogeography and ecology of the rain forests of eastern Africa: 203–228. Cambridge: Cambridge University Press.
- Sullivan, J., Z. Abdo, P. Joyce, and D.L. Swofford. 2005. Evaluating the performance of a successive-approximations approach to parameter optimization in maximum-likelihood phylogeny estimation. Molecular Biology and Evolution 22: 1386–1392.
- Swofford, D.L. 2001. PAUP\*: Phylogenetic analysis using parsimony (and other methods). Version 4.0b.10. Sunderland, MA: Sinauer Associates.
- Toews, D.P.L., and A. Brelsford. 2012. The biogeography of mitochondrial and nuclear discordance in animals. Molecular Ecology 21: 3907–3930.
- Turner, D.A. 1997. Family Musophagidae (Turacos). In J. del Hoyo, A. Elliott, and J. Sargatal (editors), Handbook of the birds of the world, Vol. 4: 480–506. Barcelona: Lynx Edicions.
- Van Tuinen, P., and M. Valentine. 1986. Phylogenetic relationships of turacos (Musophagidae; Cuculiformes) based on comparative chromosome banding analysis. Ibis 128: 364–381.



- Verheyen, R. 1956. Contribution à l'anatomie et à la systématique des touracos (Musophagi) et des coucous (Cuculiformes). *Bulletin Institut Royal des Sciences Naturelles de Belgique* 32 (23): 1–28.
- Veron, G. 1999. Phylogénie des touracos (Aves, Musophagidae). Analyse des caractères morphologiques. *Journal of Zoological Systematics and Evolutionary Research* 37: 39–47.
- Veron, G., and B.J. Winney. 2000. Phylogenetic relationships within the turacos (Musophagidae). *Ibis* 142: 446–456.
- Vieillot, L.P. 1816. *Analyse d'une nouvelle ornithologie élémentaire*. Paris: Deterville.
- Vieillot, L.P. 1819a. Le touraco Pauline ou a huppe rouge, *Opaethus erythrolophus*, Vieill. Nouveau dictionnaire d'histoire naturelle, appliquée aux arts, à l'agriculture, à l'économie rurale et domestique, à la médecine, etc. 34: 306–307. Paris: Deterville.
- Vieillot, L.P. 1819b. Le touraco-Buffon, *Opaethus buffoni*. Nouveau dictionnaire d'histoire naturelle, appliquée aux arts, à l'agriculture, à l'économie rurale et domestique, à la médecine, etc. 34: 304–305. Paris: Deterville.
- Vigors, N. 1831. *Corythaix porphyreolopha*. Proceedings of the Committee of Science and Correspondence of the Zoological Society of London: 93.
- Voelker, G., et al. 2010a. A new species of boubou (Malaconotidae: *Laniarius*) from the Albertine Rift. *Auk* 127: 678–689.
- Voelker, G., R.K. Outlaw, and R.C.K. Bowie. 2010b. Pliocene forest dynamics as a primary driver of African bird speciation. *Global Ecology and Biogeography* 19: 111–121.
- von Boetticher, H. 1947. Die systematische Gliederung der Vogelgattung *Touraco*. *Senckenbergiana* 28: 1–6.
- von Heuglin, M.T. 1855. *Corythaix leucolophus*. *Journal für Ornithologie* 3: 65.
- Wagler, J. 1827. *Spelectos* sp. 1. In *Systema avium*: [signature 8]. Stuttgart: Cottae.
- Wright, T.F., et al. 2008. A multilocus molecular phylogeny of the parrots (Psittaciformes): support for a Gondwanan origin during the Cretaceous. *Molecular Biology and Evolution* 25: 2141–2156.
- Yang, R., X. Wu, P. Yan, X. Su, and B. Yang. 2010. Complete mitochondrial genome of *Otis tarda* (Gruiformes: Otidae) and phylogeny of Gruiformes inferred from mitochondrial DNA sequences. *Molecular Biology Reports* 37: 3057–3066.
- Zink, R.M., and G.F. Barrowclough. 2008. Mitochondrial DNA under siege in avian phylogeography. *Molecular Ecology* 17: 2107–2121.
- Zwickl, D.J. 2006. Genetic algorithm approaches for the phylogenetic analysis of large biological sequence datasets under the maximum likelihood criterion. Online resource (<http://www.bio.utexas.edu/faculty/antisense/garli/Garli.html>).

## APPENDIX 1

## SPECIMENS OF MUSOPHAGIDS, AND OUTGROUPS, SEQUENCED FOR ND2

Taxon	Voucher	Locality	bp	GenBank no.	Source
<i>Corythaeola cristata</i>	AMNH DOT 10637	Central African Republic: Sangha-Mbaere Province	1041	KU160213	This study
<i>Crinifer leucogaster</i>	AMNH DOT 14740	aviary	1041	KU160214	This study
<i>Crinifer concolor</i>	AMNH DOT 5821	South Africa: Limpopo Province	1041	KU160215	This study
<i>Crinifer personatus</i>	AMNH 448561	Uganda: Western Region	1041	KU160216	This study
<i>Crinifer piscator</i>	AMNH DOT 14745	aviary	1041	KU160217	This study
<i>Crinifer zonurus</i>	AMNH 158998	Democratic Republic Congo: Haut-Uele Region	1041	KU160218	This study
<i>Gallirex johnstoni</i>	AMNH 262537	Uganda: Ruwenzori Mtns.	607	MF189322	This study
<i>Gallirex johnstoni</i>	AMNH 262538	Uganda: Ruwenzori Mtns.	607	MF189323	This study
<i>Gallirex johnstoni</i>	AMNH 262539	Uganda: Ruwenzori Mtns.	607	MF189324	This study
<i>Gallirex johnstoni</i>	AMNH 262544	Uganda: Ruwenzori Mtns.	607	MF189325	This study
<i>Gallirex johnstoni</i>	AMNH 262555	Uganda: Ruwenzori Mtns.	607	MF189326	This study
<i>Gallirex johnstoni</i>	FMNH 355261	Uganda: Ruwenzori Mtns.	607	MF189327	This study
<i>Gallirex johnstoni</i>	FMNH 355262	Uganda: Ruwenzori Mtns.	1041	KU160188	This study
<i>Gallirex kivuensis</i>	AMNH 262563	Democratic Republic Congo: Kivu Region	1041	KU160189	This study
<i>Gallirex kivuensis</i>	AMNH 262565	Democratic Republic Congo: Kivu Region	607	MF189328	This study
<i>Gallirex kivuensis</i>	AMNH 262566	Democratic Republic Congo: Kivu Region	607	MF189329	This study
<i>Gallirex kivuensis</i>	AMNH 262568	Democratic Republic Congo: Kivu Region	607	MF189330	This study
<i>Gallirex kivuensis</i>	AMNH 624137	Democratic Republic Congo: Kivu Region	607	MF189331	This study
<i>Gallirex kivuensis</i>	AMNH 624140	Rwanda: "Rugege Forest"	607	MF189332	This study
<i>Gallirex kivuensis</i>	AMNH 624141	Rwanda: "Rugege Forest"	607	MF189333	This study
<i>Gallirex porphyreolophus</i>	FMNH 282648	Mozambique: Sofala Province	607	MF189496	This study
<i>Gallirex porphyreolophus</i>	AMNH 624120	South Africa: Transvaal Province	607	MF189497	This study
<i>Gallirex porphyreolophus</i>	AMNH 624121	South Africa: Transvaal Province	607	MF189498	This study
<i>Gallirex porphyreolophus</i>	AMNH 624122	South Africa: Transvaal Province	607	MF189499	This study
<i>Gallirex porphyreolophus</i>	AMNH 624123	South Africa: Transvaal Province	607	MF189500	This study
<i>Gallirex porphyreolophus</i>	AMNH 50078	South Africa: KwaZulu- Natal Province	1041	KU160190	This study

Taxon	Voucher	Locality	bp	GenBank no.	Source
<i>Gallirex porphyreolophus</i>	AMNH 176644	South Africa: KwaZulu-Natal Province	607	MF189501	This study
<i>Gallirex chlorochlamys</i>	FMNH 193647	Kenya: Central Province	607	MF189479	This study
<i>Gallirex chlorochlamys</i>	FMNH 193645	Kenya: Coast Province	607	MF189480	This study
<i>Gallirex chlorochlamys</i>	FMNH 193646	Kenya: Coast Province	607	MF189481	This study
<i>Gallirex chlorochlamys</i>	FMNH 95372	Tanzania: Arusha Region	607	MF189482	This study
<i>Gallirex chlorochlamys</i>	AMNH 428621	Tanzania: Tabora Region	607	MF189483	This study
<i>Gallirex chlorochlamys</i>	AMNH 428622	Tanzania: Tabora Region	607	MF189484	This study
<i>Gallirex chlorochlamys</i>	AMNH 202572	Tanzania: Tabora Region	607	MF189485	This study
<i>Gallirex chlorochlamys</i>	AMNH 202573	Tanzania: Tabora Region	1041	KU160191	This study
<i>Gallirex chlorochlamys</i>	AMNH 414158	Tanzania: Tabora Region	607	MF189486	This study
<i>Gallirex chlorochlamys</i>	FMNH 205164	Zambia: Eastern Province	607	MF189487	This study
<i>Gallirex chlorochlamys</i>	FMNH 205165	Zambia: Eastern Province	607	MF189488	This study
<i>Gallirex chlorochlamys</i>	FMNH 205167	Zambia: Eastern province	607	MF189489	This study
<i>Gallirex chlorochlamys</i>	FMNH 205168	Zambia: Eastern Province	607	MF189490	This study
<i>Gallirex chlorochlamys</i>	FMNH 205169	Zambia: Eastern Province	607	MF189491	This study
<i>Gallirex chlorochlamys</i>	FMNH 474718	Malawi: Northern Region	607	MF189492	This study
<i>Gallirex chlorochlamys</i>	FMNH 474717	Malawi: Southern Region	607	MF189493	This study
<i>Gallirex chlorochlamys</i>	AMNH 624129	Malawi: Southern Region	607	MF189494	This study
<i>Gallirex chlorochlamys</i>	FMNH 471008	Malawi: Southern Region	607	MF189495	This study
<i>Menelikornis leucotis</i>	FMNH 82474	Ethiopia: Begemder Province	607	MF189352	This study
<i>Menelikornis leucotis</i>	FMNH 82479	Ethiopia: Begemder Province	1041	KU160192	This study
<i>Menelikornis leucotis</i>	FMNH 82480	Ethiopia: Begemder Province	607	MF189353	This study
<i>Menelikornis leucotis</i>	FMNH 82484	Ethiopia: Gojjam Province	607	MF189354	This study
<i>Menelikornis leucotis</i>	AMNH 624001	Ethiopia: Shewa Province	607	MF189355	This study
<i>Menelikornis leucotis</i>	AMNH 624002	Ethiopia: Shewa Province	607	MF189356	This study
<i>Menelikornis leucotis</i>	AMNH 624004	Ethiopia: Shewa Province	607	MF189357	This study
<i>Menelikornis leucotis</i>	AMNH 624010	Ethiopia: Gamu-Gofa Province	607	MF189358	This study
<i>Menelikornis donaldsoni</i>	AMNH 624022	Ethiopia: Hararghe Province	607	MF189359	This study
<i>Menelikornis donaldsoni</i>	AMNH 624023	Ethiopia: Hararghe Province	607	MF189360	This study
<i>Menelikornis donaldsoni</i>	FMNH 82495	Ethiopia: Bale Province	607	MF189361	This study
<i>Menelikornis donaldsoni</i>	AMNH 294948	Ethiopia: Arsi Province	1041	KU160193	This study
<i>Menelikornis donaldsoni</i>	FMNH 82487	Ethiopia: Arsi Province	607	MF189362	This study
<i>Menelikornis donaldsoni</i>	FMNH 82488	Ethiopia: Arsi Province	607	MF189363	This study
<i>Menelikornis donaldsoni</i>	FMNH 82493	Ethiopia: Arsi Province	607	MF189364	This study

APPENDIX 1 *continued*

Taxon	Voucher	Locality	bp	GenBank no.	Source
<i>Menelikornis donaldsoni</i>	FMNH 82494	Ethiopia: Arsi Province	607	MF189365	This study
<i>Menelikornis donaldsoni</i>	FMNH 82481	Ethiopia: Bale Province	607	MF189366	This study
<i>Menelikornis donaldsoni</i>	FMNH 82482	Ethiopia: Bale Province	607	MF189367	This study
<i>Menelikornis donaldsoni</i>	FMNH 82483	Ethiopia: Bale Province	607	MF189368	This study
<i>Menelikornis donaldsoni</i>	FMNH 82486	Ethiopia: Bale Province	607	MF189369	This study
<i>Menelikornis ruspolii</i>	AMNH 708768	Ethiopia: Sidamo Province	1041	KU160194	This study
<i>Menelikornis ruspolii</i>	BMNH 1946.5.1323	Ethiopia: Sidamo Province	607	MF189502	This study
<i>Menelikornis ruspolii</i>	BMNH 1946.5.1324	Ethiopia: Sidamo Province	607	MF189503	This study
<i>Musophaga rossae</i>	AMNH 831518	Kenya: Rift Valley Province	607	MF189181	This study
<i>Musophaga rossae</i>	AMNH 624169	Uganda: Central Region	607	MF189182	This study
<i>Musophaga rossae</i>	AMNH 624171	Uganda: Central Region	607	MF189183	This study
<i>Musophaga rossae</i>	AMNH 624172	Uganda: Central Region	607	MF189184	This study
<i>Musophaga rossae</i>	AMNH 624173	Uganda: Central Region	607	MF189185	This study
<i>Musophaga rossae</i>	YPM 10737	Uganda: Central Region	607	MF189186	This study
<i>Musophaga rossae</i>	AMNH 158958	Democratic Republic Congo: Haut-Zaïre Province	607	MF189187	This study
<i>Musophaga rossae</i>	AMNH 262579	Democratic Republic Congo: Kivu Region	1041	KU160198	This study
<i>Musophaga rossae</i>	AMNH 624164	Democratic Republic Congo: Kivu Region	607	MF189188	This study
<i>Musophaga rossae</i>	AMNH 764050	Democratic Republic Congo: Kivu Region	607	MF189189	This study
<i>Musophaga rossae</i>	AMNH 764053	Democratic Republic Congo: Kivu Region	607	MF189190	This study
<i>Musophaga rossae</i>	FMNH 301934	Democratic Republic Congo: Kivu Region	607	MF189191	This study
<i>Musophaga rossae</i>	FMNH 205172	Zambia: South Zambia	607	MF189192	This study
<i>Musophaga rossae</i>	FMNH 262839	Zambia: West Province	607	MF189193	This study
<i>Musophaga rossae</i>	YPM 50298	Angola: Lunda Province	607	MF189194	This study
<i>Musophaga rossae</i>	YPM 50299	Angola: Lunda Province	607	MF189195	This study
<i>Musophaga rossae</i>	YPM 50300	Angola: Malanje Province	607	MF189196	This study
<i>Musophaga rossae</i>	YPM 50301	Angola: Lunda Province	607	MF189197	This study
<i>Musophaga rossae</i>	YPM 50302	Angola: Malanje Province	607	MF189198	This study
<i>Musophaga rossae</i>	YPM 50304	Angola: Lunda Province	607	MF189199	This study
<i>Musophaga rossae</i>	YPM 50305	Angola: Lunda Province	607	MF189200	This study
<i>Musophaga rossae</i>	AMNH 418941	Angola: Bié Province	607	MF189201	This study
<i>Musophaga rossae</i>	AMNH 259284	Angola: Cuanza Sul Province	607	MF189202	This study
<i>Musophaga rossae</i>	AMNH 259285	Angola: Cuanza Sul Province	607	MF189203	This study

APPENDIX 1 *continued*

Taxon	Voucher	Locality	bp	GenBank no.	Source
<i>Musophaga rossae</i>	AMNH 624154	Angola: Cuanza Sul Province	607	MF189204	This study
<i>Musophaga rossae</i>	AMNH 624155	Angola: Cuanza Sul Province	607	MF189205	This study
<i>Musophaga rossae</i>	FMNH 220662	Angola: Malanje Province	607	MF189206	This study
<i>Musophaga rossae</i>	FMNH 220663	Angola: Malanje Province	607	MF189207	This study
<i>Musophaga rossae</i>	FMNH 220664	Angola: Malanje Province	607	MF189208	This study
<i>Musophaga rossae</i>	FMNH 220665	Angola: Malanje Province	607	MF189209	This study
<i>Musophaga rossae</i>	FMNH 220666	Angola: Luanda Province	607	MF189210	This study
<i>Musophaga rossae</i>	FMNH 269887	Cameroon: Adamawa Region	607	MF189211	This study
<i>Musophaga rossae</i>	FMNH 269888	Cameroon: Adamawa Region	607	MF189212	This study
<i>Musophaga violacea</i>	FMNH 269886	Cameroon: Adamawa Region	607	MF189213	This study
<i>Musophaga violacea</i>	AMNH 624152	Nigeria: Kaduna State	607	MF189214	This study
<i>Musophaga violacea</i>	AMNH 624153	Nigeria: Housaland	607	MF189215	This study
<i>Musophaga violacea</i>	FMNH 396417	Ghana: Northern Region	607	MF189216	This study
<i>Musophaga violacea</i>	FMNH 396418	Ghana: Northern Region	607	MF189217	This study
<i>Musophaga violacea</i>	FMNH 396419	Ghana: Northern Region	607	MF189218	This study
<i>Musophaga violacea</i>	FMNH 396420	Ghana: Northern Region	607	MF189219	This study
<i>Musophaga violacea</i>	FMNH 278808	Ivory Coast: Savanes District	607	MF189220	This study
<i>Musophaga violacea</i>	FMNH 285159	Ivory Coast: Savanes District	607	MF189221	This study
<i>Musophaga violacea</i>	AMNH 624147	Guinea-Bissau: Cacheu Region	1041	KU160199	This study
<i>Musophaga violacea</i>	AMNH 624148	Guinea-Bissau: Cacheu Region	607	MF189222	This study
<i>Musophaga violacea</i>	YPM 45304	Senegal: Tambacounda Region	607	MF189223	This study
<i>Musophaga macrorhyncha</i>	AMNH 623862	Sierra Leone: Southern Region	607	MF189400	This study
<i>Musophaga macrorhyncha</i>	AMNH 623863	Sierra Leone: Western Area	607	MF189401	This study
<i>Musophaga macrorhyncha</i>	AMNH 268757	Liberia: Montserrado County	607	MF189402	This study
<i>Musophaga macrorhyncha</i>	AMNH 344663	Liberia: Bong County	607	MF189403	This study
<i>Musophaga macrorhyncha</i>	AMNH 415156	Liberia: Montserrado County	607	MF189404	This study
<i>Musophaga macrorhyncha</i>	FMNH 186647	Liberia: Margibi County	607	MF189405	This study
<i>Musophaga macrorhyncha</i>	FMNH 186648	Liberia: Margibi County	607	MF189406	This study
<i>Musophaga macrorhyncha</i>	FMNH 186649	Liberia: Margibi County	607	MF189407	This study
<i>Musophaga macrorhyncha</i>	FMNH 186650	Liberia: Margibi County	607	MF189408	This study

APPENDIX 1 *continued*

Taxon	Voucher	Locality	bp	GenBank no.	Source
<i>Musophaga macrorhyncha</i>	FMNH 186651	Liberia: Margibi County	607	MF189409	This study
<i>Musophaga macrorhyncha</i>	YPM 10745	Liberia	1041	KU160200	This study
<i>Musophaga macrorhyncha</i>	YPM 76850	Liberia: Nimba County	607	MF189410	This study
<i>Musophaga verreauxii</i>	AMNH 428567	Cameroon: Southwest Region	607	MF189411	This study
<i>Musophaga verreauxii</i>	AMNH 428568	Cameroon: Southwest Region	607	MF189412	This study
<i>Musophaga verreauxii</i>	AMNH 624048	Cameroon: Southwest Region	607	MF189413	This study
<i>Musophaga verreauxii</i>	FMNH 95649	Cameroon: Southwest Region	607	MF189414	This study
<i>Musophaga verreauxii</i>	FMNH 95650	Cameroon: Southwest Region	607	MF189415	This study
<i>Musophaga verreauxii</i>	FMNH 95651	Cameroon: Southwest Region	607	MF189416	This study
<i>Musophaga verreauxii</i>	FMNH 95653	Cameroon: Southwest Region	607	MF189417	This study
<i>Musophaga verreauxii</i>	FMNH 95654	Cameroon: Southwest Region	607	MF189418	This study
<i>Musophaga verreauxii</i>	FMNH 269856	Cameroon: South Region	607	MF189419	This study
<i>Musophaga verreauxii</i>	FMNH 269857	Cameroon: South Region	607	MF189420	This study
<i>Musophaga verreauxii</i>	FMNH 269858	Cameroon: South Region	607	MF189421	This study
<i>Musophaga verreauxii</i>	FMNH 269859	Cameroon: South Region	607	MF189422	This study
<i>Musophaga verreauxii</i>	FMNH 269860	Cameroon: South Region	607	MF189423	This study
<i>Musophaga verreauxii</i>	AMNH 297328	Equatorial Guinea: Bioko Norte Province	607	MF189424	This study
<i>Musophaga verreauxii</i>	AMNH 297329	Equatorial Guinea: Bioko Norte Province	607	MF189425	This study
<i>Musophaga verreauxii</i>	AMNH 297330	Equatorial Guinea: Bioko Norte Province	607	MF189426	This study
<i>Musophaga verreauxii</i>	AMNH 624041	Equatorial Guinea: Bioko Norte Province	607	MF189427	This study
<i>Musophaga verreauxii</i>	AMNH 624043	Equatorial Guinea: Bioko Norte Province	607	MF189428	This study
<i>Musophaga verreauxii</i>	AMNH 624044	Equatorial Guinea: Bioko Norte Province	607	MF189429	This study
<i>Musophaga verreauxii</i>	YPM 100498	Equatorial Guinea: Centro Sur Province	1041	KU160201	This study
<i>Musophaga verreauxii</i>	AMNH 624051	Gabon: Ogooué River	607	MF189430	This study
<i>Musophaga verreauxii</i>	AMNH 624052	Gabon: Ogooué River	607	MF189431	This study
<i>Musophaga verreauxii</i>	AMNH 624053	Gabon: Ogooué River	607	MF189432	This study
<i>Musophaga verreauxii</i>	AMNH 624054	Gabon: Ogooué River	607	MF189433	This study
<i>Musophaga verreauxii</i>	FMNH 210612	Gabon: Ngounié Province	607	MF189434	This study
<i>Musophaga verreauxii</i>	FMNH 210613	Gabon: Ngounié Province	607	MF189435	This study



APPENDIX 1 *continued*

Taxon	Voucher	Locality	bp	GenBank no.	Source
<i>Musophaga verreauxii</i>	FMNH 215518	Gabon: Ngounié Province	607	MF189436	This study
<i>Proturacus bannermani</i>	AMNH 251194	Cameroon: Northwest Region	607	MF189224	This study
<i>Proturacus bannermani</i>	AMNH 624119	Cameroon: Northwest Region	1041	KU160195	This study
<i>Proturacus bannermani</i>	FMNH 343113	Cameroon: Northwest Region	607	MF189225	This study
<i>Proturacus bannermani</i>	FMNH 343114	Cameroon: Northwest Region	607	MF189226	This study
<i>Proturacus leucolophus</i>	FMNH 121729	Cameroon: Adamawa Region	607	MF189334	This study
<i>Proturacus leucolophus</i>	FMNH 188976	Cameroon: Adamawa Region	607	MF189335	This study
<i>Proturacus leucolophus</i>	FMNH 269884	Cameroon: Adamawa Region	607	MF189336	This study
<i>Proturacus leucolophus</i>	FMNH 269885	Cameroon: Adamawa Region	607	MF189337	This study
<i>Proturacus leucolophus</i>	FMNH 269883	Cameroon: Adamawa Region	607	MF189338	This study
<i>Proturacus leucolophus</i>	AMNH 624117	Central African Republic: Haut-Mbomou Prefecture	607	MF189339	This study
<i>Proturacus leucolophus</i>	AMNH 624118	Central African Republic: Haut-Mbomou Prefecture	607	MF189340	This study
<i>Proturacus leucolophus</i>	AMNH 158944	Democratic Republic Congo: Haut-Zaïre Province	607	MF189341	This study
<i>Proturacus leucolophus</i>	AMNH 158945	Democratic Republic Congo: Haut-Zaïre Province	607	MF189342	This study
<i>Proturacus leucolophus</i>	AMNH 158950	Democratic Republic Congo: Haut-Zaïre Province	607	MF189343	This study
<i>Proturacus leucolophus</i>	FMNH 103270	South Sudan: Eastern Equatoria State	607	MF189344	This study
<i>Proturacus leucolophus</i>	FMNH 103271	South Sudan: Eastern Equatoria State	1041	KU160197	This study
<i>Proturacus leucolophus</i>	FMNH 103272	South Sudan: Eastern Equatoria State	607	MF189345	This study
<i>Proturacus leucolophus</i>	FMNH 103273	South Sudan: Eastern Equatoria State	607	MF189346	This study
<i>Proturacus leucolophus</i>	FMNH 298235	South Sudan: Eastern Equatoria State	607	MF189347	This study
<i>Proturacus leucolophus</i>	FMNH 298236	South Sudan: Eastern Equatoria State	607	MF189348	This study

APPENDIX 1 *continued*

Taxon	Voucher	Locality	bp	GenBank no.	Source
<i>Proturacus leucolophus</i>	FMNH 298237	South Sudan: Eastern Equatoria State	607	MF189349	This study
<i>Proturacus leucolophus</i>	AMNH 624113	Kenya: Rift Valley Province	607	MF189350	This study
<i>Proturacus leucolophus</i>	AMNH 624114	Kenya: Rift Valley Province	607	MF189351	This study
<i>Proturacus erythrolophus</i>	AMNH 624036	Angola: Malanje Province	607	MF189245	This study
<i>Proturacus erythrolophus</i>	AMNH 624037	Angola: Malanje Province	607	MF189246	This study
<i>Proturacus erythrolophus</i>	AMNH 624039	Angola: Malanje Province	607	MF189247	This study
<i>Proturacus erythrolophus</i>	YPM 50278	Angola: Cuanza Sul Province	607	MF189248	This study
<i>Proturacus erythrolophus</i>	YPM 50279	Angola: Cuanza Sul Province	1041	KU160196	This study
<i>Proturacus erythrolophus</i>	YPM 50280	Angola: Cuanza Sul Province	607	MF189249	This study
<i>Proturacus erythrolophus</i>	YPM 50282	Angola: Cuanza Sul Province	607	MF189250	This study
<i>Proturacus erythrolophus</i>	AMNH 624035	Angola: Benguela Province	607	MF189251	This study
<i>Tauraco persa</i>	FMNH 285574	Ivory Coast: Vallée du Bandama District	607	MF189454	This study
<i>Tauraco persa</i>	AMNH 623869	Nigeria: Rivers State	607	MF189455	This study
<i>Tauraco persa</i>	AMNH 623870	Nigeria: Rivers State	607	MF189456	This study
<i>Tauraco persa</i>	AMNH 623871	Nigeria: Rivers State	607	MF189457	This study
<i>Tauraco persa</i>	AMNH 623872	Nigeria: Rivers State	607	MF189458	This study
<i>Tauraco persa</i>	AMNH 812107	Cameroon: Littoral Region	607	MF189459	This study
<i>Tauraco persa</i>	AMNH 415142	Cameroon: Littoral Region	607	MF189460	This study
<i>Tauraco persa</i>	AMNH 415143	Cameroon: Littoral Region	607	MF189461	This study
<i>Tauraco persa</i>	AMNH 415154	Cameroon: Littoral Region	607	MF189462	This study
<i>Tauraco persa</i>	AMNH 415138	Cameroon: Littoral Region	607	MF189463	This study
<i>Tauraco persa</i>	AMNH 415144	Cameroon: Littoral Region	607	MF189464	This study
<i>Tauraco persa</i>	AMNH 415145	Cameroon: Littoral Region	607	MF189465	This study
<i>Tauraco persa</i>	AMNH 415147	Cameroon: Littoral Region	607	MF189466	This study
<i>Tauraco persa</i>	AMNH 415148	Cameroon: Littoral Region	607	MF189467	This study
<i>Tauraco persa</i>	AMNH 415149	Cameroon: Littoral Region	607	MF189468	This study
<i>Tauraco persa</i>	AMNH 623878	Cameroon: Littoral Region	607	MF189469	This study
<i>Tauraco persa</i>	AMNH 623881	Gabon: Ogooué River	607	MF189470	This study
<i>Tauraco persa</i>	AMNH 623882	Gabon: Ogooué River	607	MF189471	This study
<i>Tauraco persa</i>	AMNH 623884	Gabon: Ogooué River	607	MF189472	This study
<i>Tauraco persa</i>	AMNH 623885	Gabon: Ogooué River	607	MF189473	This study
<i>Tauraco persa</i>	AMNH 623886	Gabon: Ogooué River	607	MF189474	This study
<i>Tauraco persa</i>	AMNH 623888	Gabon: Ogooué River	607	MF189475	This study

APPENDIX 1 *continued*

Taxon	Voucher	Locality	bp	GenBank no.	Source
<i>Tauraco persa</i>	AMNH 158914	Democratic Republic Congo: Kongo Central Province	607	MF189476	This study
<i>Tauraco persa</i>	YPM 50272	Angola: Cuanza Norte Province	1041	KU160205	This study
<i>Tauraco persa</i>	YPM 50273	Angola: Cuanza Norte Province	607	MF189477	This study
<i>Tauraco persa</i>	YPM 50274	Angola: Cuanza Norte Province	607	MF189478	This study
<i>Tauraco buffoni</i>	AMNH 623896	Guinea-Bissau: Cacheu Region	607	MF189437	This study
<i>Tauraco buffoni</i>	AMNH 623897	Guinea-Bissau: Cacheu Region	607	MF189438	This study
<i>Tauraco buffoni</i>	AMNH 623898	Guinea-Bissau: Cacheu Region	607	MF189439	This study
<i>Tauraco buffoni</i>	AMNH 623899	Sierra Leone: Southern Province	607	MF189440	This study
<i>Tauraco buffoni</i>	AMNH 623900	Sierra Leone: Northern Province	607	MF189441	This study
<i>Tauraco buffoni</i>	AMNH 623902	Sierra Leone: Northern Province	607	MF189442	This study
<i>Tauraco buffoni</i>	AMNH 623903	Sierra Leone: Western Province	607	MF189443	This study
<i>Tauraco buffoni</i>	FMNH 186636	Liberia: Nimba County	607	MF189444	This study
<i>Tauraco buffoni</i>	FMNH 186637	Liberia: Nimba County	607	MF189445	This study
<i>Tauraco buffoni</i>	FMNH 186638	Liberia: Nimba County	607	MF189446	This study
<i>Tauraco buffoni</i>	FMNH 186639	Liberia: Nimba County	607	MF189447	This study
<i>Tauraco buffoni</i>	FMNH 186640	Liberia: Nimba County	607	MF189448	This study
<i>Tauraco buffoni</i>	FMNH 186641	Liberia: Nimba County	607	MF189449	This study
<i>Tauraco buffoni</i>	FMNH 186642	Liberia: Nimba County	607	MF189450	This study
<i>Tauraco buffoni</i>	FMNH 186643	Liberia: Nimba County	607	MF189451	This study
<i>Tauraco buffoni</i>	FMNH 186644	Liberia: Nimba County	607	MF189452	This study
<i>Tauraco buffoni</i>	YPM 76848	Ivory Coast: Montagnes District	1041	KU160206	This study
<i>Tauraco buffoni</i>	YPM 76849	Ivory Coast: Montagnes District	607	MF189453	This study
<i>Tauraco emini</i>	FMNH 298238	South Sudan: Eastern Equatoria Province	1041	KU160202	This study
<i>Tauraco emini</i>	FMNH 298239	South Sudan: Eastern Equatoria Province	607	MF189533	This study
<i>Tauraco emini</i>	FMNH 193612	Uganda: Central Region	607	MF189534	This study
<i>Tauraco emini</i>	AMNH 623960	Uganda: Central Region	607	MF189535	This study
<i>Tauraco emini</i>	FMNH 193614	Uganda: Western Region	607	MF189536	This study
<i>Tauraco emini</i>	FMNH 193615	Uganda: Western Region	607	MF189537	This study

APPENDIX 1 *continued*

Taxon	Voucher	Locality	bp	GenBank no.	Source
<i>Tauraco emini</i>	FMNH 193616	Uganda: Western Region	607	MF189538	This study
<i>Tauraco emini</i>	FMNH 193617	Uganda: Western Region	607	MF189539	This study
<i>Tauraco emini</i>	FMNH 357943	Rwanda: Butare Province	607	MF189540	This study
<i>Tauraco emini</i>	FMNH 357944	Burundi: Western Burundi	607	MF189541	This study
<i>Tauraco emini</i>	AMNH 262535	Democratic Republic Congo: North Kivu	607	MF189542	This study
<i>Tauraco emini</i>	AMNH 450787	Democratic Republic Congo: Kivu State	607	MF189543	This study
<i>Tauraco emini</i>	AMNH 623971	Democratic Republic Congo: Kivu State	607	MF189544	This study
<i>Tauraco emini</i>	AMNH 623973	Democratic Republic Congo: Kivu State	607	MF189545	This study
<i>Tauraco emini</i>	AMNH 623974	Democratic Republic Congo: Kivu State	607	MF189546	This study
<i>Tauraco emini</i>	AMNH 623976	Democratic Republic Congo: Kivu State	607	MF189547	This study
<i>Tauraco emini</i>	AMNH 764047	Democratic Republic Congo: Kivu State	607	MF189548	This study
<i>Tauraco hartlaubi</i>	FMNH 369554	Kenya: Marsabit Co.; Mt. Kulal	607	MF189265	This study
<i>Tauraco hartlaubi</i>	FMNH 369556	Kenya: Marsabit Co.; Mt. Kulal	607	MF189266	This study
<i>Tauraco hartlaubi</i>	FMNH 193608	Kenya: Samburu Co.; Mt. Nyiru	607	MF189267	This study
<i>Tauraco hartlaubi</i>	FMNH 193609	Kenya: Samburu Co.; Mt. Nyiru	607	MF189268	This study
<i>Tauraco hartlaubi</i>	AMNH 624062	Uganda: Eastern Region; Mt. Elgon	607	MF189269	This study
<i>Tauraco hartlaubi</i>	AMNH 624063	Uganda: Eastern Region; Mt. Elgon	607	MF189270	This study
<i>Tauraco hartlaubi</i>	AMNH 624064	Uganda: Eastern Region; Mt. Elgon	607	MF189271	This study
<i>Tauraco hartlaubi</i>	AMNH 123749	Kenya: Uasin-Gishu Co.	607	MF189272	This study
<i>Tauraco hartlaubi</i>	AMNH 123750	Kenya: Uasin-Gishu Co.	607	MF189273	This study
<i>Tauraco hartlaubi</i>	AMNH 624071	Kenya: Uasin-Gishu Co.	607	MF189274	This study
<i>Tauraco hartlaubi</i>	AMNH 624066	Kenya: Nakuru Co.; Molo	607	MF189275	This study
<i>Tauraco hartlaubi</i>	AMNH 624067	Kenya: Nakuru Co., Molo	607	MF189276	This study
<i>Tauraco hartlaubi</i>	AMNH 624068	Kenya: Nakuru Co.; Subugo	607	MF189277	This study
<i>Tauraco hartlaubi</i>	AMNH 624069	Kenya: Nakuru Co.; Subugo	607	MF189278	This study
<i>Tauraco hartlaubi</i>	AMNH 624070	Kenya: Nakuru Co., Subugo	607	MF189279	This study
<i>Tauraco hartlaubi</i>	AMNH 624095	Kenya: Meru Co.	607	MF189280	This study
<i>Tauraco hartlaubi</i>	AMNH 624096	Kenya: Meru Co.	607	MF189281	This study

APPENDIX 1 *continued*

Taxon	Voucher	Locality	bp	GenBank no.	Source
<i>Tauraco hartlaubi</i>	AMNH 799887	Kenya: Meru Co.	607	MF189282	This study
<i>Tauraco hartlaubi</i>	AMNH 799888	Kenya: Meru Co.	607	MF189283	This study
<i>Tauraco hartlaubi</i>	AMNH 262527	Kenya: Kirinyaga Co.; Mt. Kenya	607	MF189284	This study
<i>Tauraco hartlaubi</i>	AMNH 262528	Kenya: Kirinyaga Co.; Mt. Kenya	607	MF189285	This study
<i>Tauraco hartlaubi</i>	YPM 49019	Kenya: Mt. Kenya	607	MF189286	This study
<i>Tauraco hartlaubi</i>	YPM 49020	Kenya: Mt. Kenya	607	MF189287	This study
<i>Tauraco hartlaubi</i>	YPM 49023	Kenya: Mt. Kenya	607	MF189288	This study
<i>Tauraco hartlaubi</i>	YPM 49024	Kenya: Mt. Kenya	607	MF189289	This study
<i>Tauraco hartlaubi</i>	YPM 49025	Kenya: Mt. Kenya	607	MF189290	This study
<i>Tauraco hartlaubi</i>	AMNH 414156	Kenya: Nyeri Co.	607	MF189291	This study
<i>Tauraco hartlaubi</i>	AMNH 414157	Kenya: Nyeri Co.	607	MF189292	This study
<i>Tauraco hartlaubi</i>	AMNH 414160	Kenya: Nyeri Co.	607	MF189293	This study
<i>Tauraco hartlaubi</i>	YPM 80017	Kenya: Nyeri Co.	607	MF189294	This study
<i>Tauraco hartlaubi</i>	YPM 80018	Kenya: Nyeri Co.	607	MF189295	This study
<i>Tauraco hartlaubi</i>	AMNH 624075	Kenya: Kiambu Co.	607	MF189296	This study
<i>Tauraco hartlaubi</i>	AMNH 624076	Kenya: Kiambu Co.	607	MF189297	This study
<i>Tauraco hartlaubi</i>	AMNH 624078	Kenya: Kiambu Co.	607	MF189298	This study
<i>Tauraco hartlaubi</i>	AMNH 624085	Kenya: Kiambu Co.	607	MF189299	This study
<i>Tauraco hartlaubi</i>	AMNH 624087	Kenya: Kiambu Co.	607	MF189300	This study
<i>Tauraco hartlaubi</i>	AMNH 208478	Kenya: Kajiado Co.; Ngong	607	MF189301	This study
<i>Tauraco hartlaubi</i>	AMNH 208479	Kenya: Kajiado Co.; Ngong	607	MF189302	This study
<i>Tauraco hartlaubi</i>	AMNH 208480	Kenya: Kajiado Co.; Ngong	607	MF189303	This study
<i>Tauraco hartlaubi</i>	AMNH 208481	Kenya: Kajiado Co.; Ngong	607	MF189304	This study
<i>Tauraco hartlaubi</i>	AMNH 208482	Kenya: Kajiado Co.; Ngong	607	MF189305	This study
<i>Tauraco hartlaubi</i>	AMNH 208484	Kenya: Kajiado Co.; Ngong	607	MF189306	This study
<i>Tauraco hartlaubi</i>	AMNH 624091	Kenya: Kiambu Co.	607	MF189307	This study
<i>Tauraco hartlaubi</i>	AMNH 624088	Kenya: Nairobi	607	MF189308	This study
<i>Tauraco hartlaubi</i>	AMNH 624089	Kenya: Nairobi	607	MF189309	This study
<i>Tauraco hartlaubi</i>	AMNH 624090	Kenya: Nairobi	607	MF189310	This study
<i>Tauraco hartlaubi</i>	AMNH 624057	Tanzania: Kilimanjaro Region	607	MF189311	This study
<i>Tauraco hartlaubi</i>	AMNH 624058	Tanzania: Kilimanjaro Region	607	MF189312	This study
<i>Tauraco hartlaubi</i>	AMNH 624059	Tanzania: Kilimanjaro Region	607	MF189313	This study
<i>Tauraco hartlaubi</i>	AMNH 624060	Tanzania: Kilimanjaro Region	607	MF189314	This study
<i>Tauraco hartlaubi</i>	AMNH 624061	Tanzania: Kilimanjaro Region	607	MF189315	This study

APPENDIX 1 *continued*

Taxon	Voucher	Locality	bp	GenBank no.	Source
<i>Tauraco hartlaubi</i>	YPM 88428	Tanzania: Tanga Region; Usambara Mtns.	607	MF189316	This study
<i>Tauraco hartlaubi</i>	YPM 88429	Tanzania: Tanga Region; Usambara Mtns.	607	MF189317	This study
<i>Tauraco hartlaubi</i>	YPM 88430	Tanzania: Tanga Region; Usambara Mtns.	607	MF189318	This study
<i>Tauraco hartlaubi</i>	YPM 88431	Tanzania: Tanga Region; Usambara Mtns.	607	MF189319	This study
<i>Tauraco hartlaubi</i>	YPM 88432	Tanzania: Tanga Region; Usambara Mtns.	607	MF189320	This study
<i>Tauraco hartlaubi</i>	YPM 88433	Tanzania: Tanga Region; Usambara Mtns.	607	MF189321	This study
<i>Tauraco hartlaubi</i>	YPM 88434	Tanzania: Tanga Region; Usambara Mtns.	1041	KU160204	This study
<i>Tauraco fischeri</i>	FMNH 193643	Somalia: Jubba River	607	MF189252	This study
<i>Tauraco fischeri</i>	FMNH 193644	Somalia: Jubba River	607	MF189253	This study
<i>Tauraco fischeri</i>	AMNH 624031	Kenya: Tana River Co.	607	MF189254	This study
<i>Tauraco fischeri</i>	AMNH 624032	Kenya: Tana River Co.	607	MF189255	This study
<i>Tauraco fischeri</i>	AMNH 208476	Kenya: Tana River Co.	607	MF189256	This study
<i>Tauraco fischeri</i>	FMNH 193638	Kenya: Kilifi Co.	607	MF189257	This study
<i>Tauraco fischeri</i>	FMNH 193639	Kenya: Kilifi Co.	607	MF189258	This study
<i>Tauraco fischeri</i>	YPM 79792	Kenya: Kilifi Co.	607	MF189259	This study
<i>Tauraco fischeri</i>	YPM 79793	Kenya: Kilifi Co.	1041	KU160207	This study
<i>Tauraco fischeri</i>	YPM 88422	Tanzania: Tanga Region; Usambara Mtns.	607	MF189260	This study
<i>Tauraco fischeri</i>	YPM 88423	Tanzania: Tanga Region; Usambara Mtns.	607	MF189261	This study
<i>Tauraco fischeri</i>	YPM 88424	Tanzania: Tanga Region; Usambara Mtns.	607	MF189262	This study
<i>Tauraco fischeri</i>	YPM 88426	Tanzania: Tanga Region; Usambara Mtns.	607	MF189263	This study
<i>Tauraco fischeri</i>	YPM 88427	Tanzania: Tanga Region; Usambara Mtns.	607	MF189264	This study
<i>Tauraco fischeri</i>	BMNH (Tring) 1938.5.6.1	Tanzania: Zanzibar; Unguja Island.	607	MN529996	This study
<i>Tauraco reichenowi</i>	AMNH 202570	Tanzania: Morogoro Region; Uluguru Mtns.	607	MF189370	This study
<i>Tauraco reichenowi</i>	AMNH 202571	Tanzania: Morogoro Region; Uluguru Mtns.	607	MF189371	This study
<i>Tauraco reichenowi</i>	AMNH 258971	Tanzania: Morogoro Region; Uluguru Mtns.	607	MF189372	This study
<i>Tauraco reichenowi</i>	YPM 88408	Tanzania: Morogoro Region; Uluguru Mtns.	1041	KU160208	This study



APPENDIX 1 *continued*

Taxon	Voucher	Locality	bp	GenBank no.	Source
<i>Tauraco reichenowi</i>	YPM 88409	Tanzania: Morogoro Region; Uluguru Mtns.	607	MF189373	This study
<i>Tauraco reichenowi</i>	YPM 88413	Tanzania: Morogoro Region; Uluguru Mtns.	607	MF189374	This study
<i>Tauraco reichenowi</i>	YPM 88414	Tanzania: Morogoro Region; Uluguru Mtns.	607	MF189375	This study
<i>Tauraco reichenowi</i>	YPM 88415	Tanzania: Morogoro Region; Uluguru Mtns.	607	MF189376	This study
<i>Tauraco reichenowi</i>	YPM 88410	Tanzania: Iringa Region	607	MF189377	This study
<i>Tauraco reichenowi</i>	YPM 88416	Tanzania: Iringa Region	607	MF189378	This study
<i>Tauraco reichenowi</i>	YPM 88420	Tanzania: Njombe Region	607	MF189379	This study
<i>Tauraco reichenowi</i>	YPM 88421	Tanzania: Njombe Region	607	MF189380	This study
<i>Tauraco reichenowi</i>	AMNH 416217	Tanzania: Mbeya Region	607	MF189381	This study
<i>Tauraco reichenowi</i>	AMNH 416218	Tanzania: Mbeya Region	607	MF189382	This study
<i>Tauraco reichenowi</i>	AMNH 416219	Tanzania: Mbeya Region	607	MF189383	This study
<i>Tauraco reichenowi</i>	AMNH 416221	Tanzania: Mbeya Region	607	MF189384	This study
<i>Tauraco reichenowi</i>	YPM 88411	Tanzania: Mbeya Region	607	MF189385	This study
<i>Tauraco reichenowi</i>	YPM 88417	Tanzania: Mbeya Region	607	MF189386	This study
<i>Tauraco reichenowi</i>	YPM 88418	Tanzania: Mbeya Region	607	MF189387	This study
<i>Tauraco corythaix</i>	AMNH 623905	South Africa: Transvaal	607	MF189229	This study
<i>Tauraco corythaix</i>	AMNH 50075	South Africa: KwaZulu-Natal Province	607	MF189230	This study
<i>Tauraco corythaix</i>	AMNH 176641	South Africa: KwaZulu-Natal Province	607	MF189231	This study
<i>Tauraco corythaix</i>	AMNH 176642	South Africa: KwaZulu-Natal Province	607	MF189232	This study
<i>Tauraco corythaix</i>	AMNH 201485	South Africa: KwaZulu-Natal Province	607	MF189233	This study
<i>Tauraco corythaix</i>	AMNH 623906	South Africa: KwaZulu-Natal Province	607	MF189234	This study
<i>Tauraco corythaix</i>	YPM 72559	South Africa: KwaZulu-Natal Province	607	MF189235	This study
<i>Tauraco corythaix</i>	YPM 72560	South Africa: KwaZulu-Natal Province	607	MF189236	This study
<i>Tauraco corythaix</i>	YPM 72561	South Africa: KwaZulu-Natal Province	607	MF189237	This study
<i>Tauraco corythaix</i>	YPM 72363	South Africa: KwaZulu-Natal Province	607	MF189238	This study
<i>Tauraco corythaix</i>	YPM 78532	South Africa: KwaZulu-Natal Province	1041	KU160209	This study
<i>Tauraco corythaix</i>	FMNH 256674	South Africa: Eastern Cape Province	607	MF189239	This study

APPENDIX 1 *continued*

Taxon	Voucher	Locality	bp	GenBank no.	Source
<i>Tauraco corythaix</i>	FMNH 256675	South Africa: Eastern Cape Province	607	MF189240	This study
<i>Tauraco corythaix</i>	AMNH 623913	South Africa: Western Cape Province	607	MF189241	This study
<i>Tauraco corythaix</i>	AMNH 623915	South Africa: Western Cape Province	607	MF189242	This study
<i>Tauraco corythaix</i>	FMNH 471005	South Africa: Western Cape Province	607	MF189243	This study
<i>Tauraco corythaix</i>	FMNH 92701	South Africa: Western Cape Province	607	MF189244	This study
<i>Tauraco livingstonii</i>	AMNH 416220	Malawi: Southern Region	607	MF189388	This study
<i>Tauraco livingstonii</i>	AMNH 416222	Malawi: Southern Region	607	MF189389	This study
<i>Tauraco livingstonii</i>	AMNH 416223	Malawi: Southern Region	607	MF189390	This study
<i>Tauraco livingstonii</i>	AMNH 623918	Malawi: Southern Region	607	MF189391	This study
<i>Tauraco livingstonii</i>	AMNH 623919	Malawi: Southern Region	607	MF189392	This study
<i>Tauraco livingstonii</i>	AMNH 623920	Malawi: Southern Region	607	MF189393	This study
<i>Tauraco livingstonii</i>	AMNH 623921	Malawi: Southern Region	1041	KU160210	This study
<i>Tauraco livingstonii</i>	FMNH 447245	Malawi: Southern Region	607	MF189394	This study
<i>Tauraco livingstonii</i>	FMNH 447246	Malawi: Southern Region	607	MF189395	This study
<i>Tauraco livingstonii</i>	FMNH 447247	Malawi: Southern Region	607	MF189396	This study
<i>Tauraco livingstonii</i>	AMNH 623922	Mozambique: Nampula Province	607	MF189397	This study
<i>Tauraco livingstonii</i>	AMNH 623923	Mozambique: Nampula Province	607	MF189398	This study
<i>Tauraco livingstonii</i>	AMNH 623924	Mozambique: Nampula Province	607	MF189399	This study
<i>Tauraco schuettii</i>	AMNH 257925	Democratic Republic Congo: Kasai-Occidental Province	607	MF189549	This study
<i>Tauraco schuettii</i>	AMNH 257926	Democratic Republic Congo: Kasai-Occidental Province	607	MF189550	This study
<i>Tauraco schuettii</i>	AMNH 257927	Democratic Republic Congo: Kasai-Occidental Province	607	MF189551	This study
<i>Tauraco schuettii</i>	AMNH 257928	Democratic Republic Congo: Kasai-Occidental Province	607	MF189552	This study
<i>Tauraco schuettii</i>	AMNH 257929	Democratic Republic Congo: Kasai-Occidental Province	607	MF189553	This study
<i>Tauraco schuettii</i>	AMNH 257930	Democratic Republic Congo: Kasai-Occidental Province	1041	KU160203	This study

APPENDIX 1 *continued*

Taxon	Voucher	Locality	bp	GenBank no.	Source
<i>Tauraco schuettii</i>	AMNH 257931	Democratic Republic Congo: Kasai-Occidental Province	607	MF189554	This study
<i>Tauraco schuettii</i>	AMNH 257932	Democratic Republic Congo: Kasai-Occidental Province	607	MF189555	This study
<i>Tauraco schuettii</i>	AMNH 257933	Democratic Republic Congo: Kasai-Occidental Province	607	MF189556	This study
<i>Tauraco schuettii</i>	AMNH 623953	Democratic Republic Congo: Kasai-Occidental Province	607	MF189557	This study
<i>Tauraco schuettii</i>	AMNH 296714	Democratic Republic Congo: Équateur Province	607	MF189558	This study
<i>Tauraco schuettii</i>	AMNH 296716	Democratic Republic Congo: Équateur Province	607	MF189559	This study
<i>Tauraco schuettii</i>	AMNH 296717	Democratic Republic Congo: Équateur Province	607	MF189560	This study
<i>Tauraco schuettii</i>	AMNH 296719	Democratic Republic Congo: Équateur Province	607	MF189561	This study
<i>Tauraco schuettii</i>	AMNH 296722	Democratic Republic Congo: Équateur Province	607	MF189562	This study
<i>Tauraco schuettii</i>	AMNH 296726	Democratic Republic Congo: Équateur Province	607	MF189563	This study
<i>Tauraco schuettii</i>	YPM 50277	Angola: Lunda Province	607	MF189564	This study
<i>Tauraco chalcophus</i>	FMNH 95371	Tanzania: Arusha Region	1041	KU160211	This study
<i>Tauraco chalcophus</i>	AMNH 623930	Tanzania: Manyara Region	607	MF189227	This study
<i>Tauraco chalcophus</i>	AMNH 623931	Tanzania: Manyara Region	607	MF189228	This study
<i>Tauraco loitanus</i>	AMNH 623927	Kenya: Narok Co.	607	MF189504	This study
<i>Tauraco loitanus</i>	AMNH 831519	Kenya: Narok Co.	1041	MF189505	This study
<i>Tauraco marungensis</i>	YPM 88403	Tanzania: Rukwa Region	607	MF189506	This study
<i>Tauraco marungensis</i>	YPM 88404	Tanzania: Rukwa Region	607	MF189507	This study
<i>Tauraco marungensis</i>	YPM 88405	Tanzania: Rukwa Region	607	MF189508	This study
<i>Tauraco marungensis</i>	YPM 88406	Tanzania: Rukwa Region	1041	KU160212	This study
<i>Tauraco marungensis</i>	YPM 88412	Tanzania: Mbeya Region	607	MF189509	This study
<i>Tauraco marungensis</i>	AMNH 416224	Malawi: Northern Region	607	MF189510	This study
<i>Tauraco marungensis</i>	FMNH 440433	Malawi: Northern Region	607	MF189511	This study
<i>Tauraco marungensis</i>	FMNH 440434	Malawi: Northern Region	607	MF189512	This study
<i>Tauraco marungensis</i>	FMNH 440435	Malawi: Northern Region	607	MF189513	This study
<i>Tauraco marungensis</i>	FMNH 444026	Malawi: Central Region	607	MF189514	This study
<i>Tauraco marungensis</i>	FMNH 444027	Malawi: Central Region	607	MF189515	This study
<i>Tauraco marungensis</i>	FMNH 444028	Malawi: Central Region	607	MF189516	This study
<i>Tauraco marungensis</i>	FMNH 444029	Malawi: Central Region	607	MF189517	This study

APPENDIX 1 *continued*

Taxon	Voucher	Locality	bp	GenBank no.	Source
<i>Tauraco marungensis</i>	FMNH 444030	Malawi: Central Region	607	MF189518	This study
<i>Tauraco marungensis</i>	AMNH 347342	Zambia: Luapula Province	607	MF189519	This study
<i>Tauraco schalowi</i>	AMNH 623934	Angola: Huambo Province	607	MF189520	This study
<i>Tauraco schalowi</i>	AMNH 623935	Angola: Huambo Province	607	MF189521	This study
<i>Tauraco schalowi</i>	AMNH 623936	Angola: "Bingondo"	607	MF189522	This study
<i>Tauraco schalowi</i>	AMNH 623937	Angola: Bié Province	607	MF189523	This study
<i>Tauraco schalowi</i>	AMNH 623938	Angola: Bié Province	607	MF189524	This study
<i>Tauraco schalowi</i>	AMNH 623939	Angola: Bié Province	607	MF189525	This study
<i>Tauraco schalowi</i>	AMNH 623941	Angola: Bié Province	607	MF189526	This study
<i>Tauraco schalowi</i>	AMNH 259278	Angola: Cuanza Sul Province	607	MF189527	This study
<i>Tauraco schalowi</i>	AMNH 259281	Angola: Cuanza Sul Province	607	MF189528	This study
<i>Tauraco schalowi</i>	AMNH 259282	Angola: Cuanza Sul Province	607	MF189529	This study
<i>Tauraco schalowi</i>	AMNH 259283	Angola: Cuanza Sul Province	607	MF189530	This study
<i>Tauraco schalowi</i>	YPM 50275	Angola: Bié Province	1041	MF189531	This study
<i>Tauraco schalowi</i>	YPM50276	Angola: Bié Province	607	MF189532	This study
<i>Ciconia ciconia</i>	Unknown	Unknown	1041	NC002197	NCBI Genome Project
<i>Otis tarda</i>	Unknown	Unknown	1041	NC014046	Yang et al. (2010)
<i>Antigone canadensis</i>	Intl. Crane Foundation 7-31	aviary	1041	FJ769855	Krajewski et al. (2010)
<i>Coccyzus americanus</i>	Unknown	Unknown	1041	EU327609	Wright et al. (2008)

APPENDIX 2  
SPECIMENS OF MUSOPHAGIDS, AND OUTGROUPS, SEQUENCED  
FOR ACO1: INTRON 15<sup>a</sup>

Taxon	Voucher	Locality	bp	GenBank no.
<i>Corythaeola cristata</i>	AMNH DOT 8076	Central African Republic: Sangha-Mbaere Prefecture	559	KT372832
<i>Crinifer leucogaster</i>	AMNH DOT 14740	aviary	544	KT372827
<i>Crinifer concolor</i>	AMNH DOT 5821	South Africa: Limpopo Province	559	KT372830
<i>Crinifer personatus</i>	ZMUC 130716	aviary	559	KT372831
<i>Crinifer piscator</i>	AMNH DOT 14745	aviary	560	KT372828
<i>Crinifer zonurus</i>	AMNH 624199	Eritrea: Debub Region	560	KT372829
<i>Gallirex johnstoni</i>	FMNH 355262	Uganda: Western District	552	KT372802
<i>Gallirex kivuensis</i>	AMNH 262563	Democratic Republic Congo: Kivu Region	552	KT372803
<i>Gallirex porphyreolophus</i>	AMNH 50078	South Africa: KwaZulu-Natal Province	551	KT372804
<i>Gallirex chlorochlamys</i>	FMNH 452484	Malawi: Northern Region	551	KT372805
<i>Proturacus bannermani</i>	FMNH 343113	Cameroon: Northwest Region	552	KT372810
<i>Proturacus erythrolophus</i>	YPM 50279	Angola: Cuanza Sul Province	552	KT372812
<i>Proturacus leucolophus</i>	FMNH 103271	South Sudan: Eastern Equatorial State	552	KT372811
<i>Musophaga rossae</i>	ZMUC 128747	Democratic Republic Congo: Kivu Region	551	KT372806
<i>Musophaga violacea</i>	FMNH 396419	Ghana: Northern Region	551	KT372807
<i>Musophaga macrorhyncha</i>	YPM 10745	Liberia	552	KT372808
<i>Musophaga verreauxii</i>	YPM 100498	Equatorial Guinea: Centro Sur Province	552	KT372809
<i>Menelikornis leucotis</i>	ZMUC 131942	aviary	552	KT372813
<i>Menelikornis ruspolii</i>	FMNH 193625	Ethiopia: Sidamo Province	551	KT372814
<i>Menelikornis donaldsoni</i>	AMNH 188873	no data	552	KT372815
<i>Tauraco emini</i>	FMNH 298238	South Sudan: Western Equatorial State	552	KT372825
<i>Tauraco hartlaubi</i>	ZMUC 146783	Kenya	552	KT372826
<i>Tauraco persa</i>	FMNH 95642	Benin: Plateau Department	552	KT372823
<i>Tauraco buffoni</i>	ZMUC 130725	aviary	552	KT372824
<i>Tauraco reichenowi</i>	YPM 88409	Tanzania: Morogoro Region	552	KT372820
<i>Tauraco fischeri</i>	ZMUC 142855	Tanzania: Tanga Region	552	KT372819
<i>Tauraco livingstonii</i>	AMNH 416220	Malawi: Southern Region	552	KT372821
<i>Tauraco schuettii</i>	AMNH 623953	Democratic Republic Congo: Kasai Occidental Province	552	KT372816
<i>Tauraco chalcophus</i>	FMNH 95371	Tanzania: Arusha Region	552	KT372818
<i>Tauraco schalowi</i>	YPM 50275	Angola: Bié Province	552	MF766008

APPENDIX 2 *continued*

Taxon	Voucher	Locality	bp	GenBank no.
<i>Tauraco corythaix</i>	YPM 72559	South Africa: KwaZulu-Natal Province	552	KT372822
<i>Tauraco loitanus</i>	AMNH 831519	Kenya: Narok District	552	MF766009
<i>Tauraco marungensis</i>	FMNH 444029	Malawi: Central Region	552	KT372817
<i>Ciconia ciconia</i>	AMNH skel 23687	Austria: Burgenland	556	KT372834
<i>Otis tarda</i>	AMNH DOT 14728	Hungary: Békés County	555	KT372836
<i>Antigone canadensis</i>	AMNH DOT 10113	U.S.: Florida	562	KT372835
<i>Coccyzus americanus</i>	AMNH AC18	U.S.: Texas	549	KT372833

<sup>a</sup> All sequences new for this study.



APPENDIX 3  
SPECIMENS OF MUSOPHAGIDS, AND OUTGROUPS, SEQUENCED FOR RAG-1

Taxon	Voucher	Locality	bp	GenBank no.	Source
<i>Corythaeola cristata</i>	AMNH DOT 10637	Central African Republic: Sangha-Mbaere Prefecture	2872	KT424072	This study
<i>Crinifer leucogaster</i>	AMNH DOT 14740	aviary	2872	KT424073	This study
<i>Crinifer concolor</i>	AMNH DOT 5808	South Africa: Limpopo Province	2872	KT424074	This study
<i>Crinifer personatus</i>	ZMUC 130716	aviary	2872	KT424075	This study
<i>Crinifer piscator</i>	AMNH DOT 14745	aviary	2872	KT424076	This study
<i>Gallirex johnstoni</i>	FMNH 355262	Uganda: Western District	2872	KT424077	This study
<i>Gallirex porphyreolophus</i>	UWBM 52953	South Africa: KwaZulu-Natal Province	2872	KT424078	This study
<i>Gallirex chlorochlamys</i>	FMNH 474717	Malawi: Southern Region	2872	KT424079	This study
<i>Proturacus erythrolophus</i>	AMNH DOT 10121	aviary	2872	DQ482643	Barrowclough et al. (2006)
<i>Proturacus leucolophus</i>	YPM 84727	aviary	2872	KT424080	This study
<i>Musophaga rossae</i>	ZMUC 128747	Democratic Republic Congo: Kivu Region	2872	KT424081	This study
<i>Musophaga violacea</i>	FMNH 396417	Ghana: Northern Region	2872	KT424082	This study
<i>Musophaga macrorhyncha</i>	KUNHM 15603	Ghana: Western Region	2872	KT424083	This study
<i>Musophaga verreauxii</i>	YPM 100498	Equatorial Guinea: Centro Sur Province	2872	KT424084	This study
<i>Menelikornis leucotis</i>	ZMUC 131942	aviary	2872	KT424085	This study
<i>Tauraco emini</i>	FMNH 357944	Burundi: Cibitoke Province	2872	KT424086	This study
<i>Tauraco hartlaubi</i>	ZMUC 114847	Tanzania: Arusha Region	2872	KT424087	This study
<i>Tauraco persa</i>	AMNH DOT 7126	aviary	2872	KT424088	This study
<i>Tauraco buffoni</i>	ZMUC 130725	aviary	2872	KT424089	This study
<i>Tauraco reichenowii</i>	UWBM 90400	aviary	2872	KT424090	This study
<i>Tauraco fischeri</i>	ZMUC 142855	Tanzania: Tanga Region	2872	KT424091	This study
<i>Tauraco livingstonii</i>	FMNH 447247	Malawi: Southern Region	2872	KT424092	This study
<i>Tauraco corythaix</i>	UWBM 95352	South Africa: Western Cape Province	2872	KT424093	This study

APPENDIX 3 *continued*

Taxon	Voucher	Locality	bp	GenBank no.	Source
<i>Tauraco marungensis</i>	FMNH 444030	Malawi: Central Region	2872	KT424094	This study
<i>Ciconia ciconia</i>	AMNH skel 23687	Austria: Burgenland	2872	KT424095	This study
<i>Otis tarda</i>	AMNH DOT 14728	Hungary: Békés County	2872	KT424096	This study
<i>Antigone canadensis</i>	AMNH DOT 10113	U.S.: Florida	2869	AF143732	Groth and Barrowclough (1999)
<i>Coccyzus americanus</i>	AMNH AC18	U.S.: Texas	2872	DQ482640	Barrowclough et al. (2006)

APPENDIX 4  
PHENOTYPE, HAPLOTYPE, AND GEOGRAPHY OF SPECIMENS OF *GALLIREX PORPHYREOLOPHUS*

Voucher <sup>a</sup>	Label locality	Current administrative division	Latitude	Longitude	Phenotype	ND2 haplotype
624130	"Machakos"	Kenya: Machakos Co.	1° 31'S	37° 16'E	chlorochlamys	
202572	"Dombolo, Tabora. T. T."	Tanzania: Tabora Region	~5°S	~34°E	chlorochlamys	chlorochlamys
202573	"Dombolo, Tabora. T. T."	Tanzania: Tabora Region	~5°S	~34°E	chlorochlamys	chlorochlamys
428621	"Mawere, T. T."	Tanzania: Tabora Region	5° 18'S	32° 45'E	chlorochlamys	chlorochlamys
428622	"Mawere T. T."	Tanzania: Tabora Region	5° 18'S	32° 45'E	chlorochlamys	chlorochlamys
414158	"Mtoni, Tanganyika Teri."	Tanzania: Tabora Region	6° 15'S	32° 19'E	chlorochlamys	chlorochlamys
414159	"Mtoni"	Tanzania: Tabora Region	6° 15'S	32° 19'E	chlorochlamys	chlorochlamys
624129	"Monkey Bay, Lake Nyasa B.C Africa."	Malawi: Southern Region	14° 05'S	34° 55'E	chlorochlamys	chlorochlamys
624128	Luchenza, Nyasaland	Malawi: Southern Region	16° 03'S	35° 17'E	chlorochlamys	
FMNH 282648	Dondo Forest, 25 mi. NE Dondo, Sofala Prov., Mozam- bique	Mozambique: Sofala Prov.	19° 37'S	34° 45'E	porphyreolophus	porphyreolophus
414706	"Zimbabwe"	Zimbabwe: Masvingo Prov.	20° 16'S	30° 56'E	porphyreolophus	
844007	"Zimbabwe"	Zimbabwe: Masvingo Prov.	20° 16'S	30° 56'E	porphyreolophus	
624120	"Hector Spruit"	South Africa: Mpumalanga Prov.	25° 26'S	31° 41'E	porphyreolophus	chlorochlamys
624121	"Hector Spruit"	South Africa: Mpumalanga Prov.	25° 26'S	31° 41'E	porphyreolophus	porphyreolophus
624122	"Hector Spruit"	South Africa: Mpumalanga Prov.	25° 26'S	31° 41'E	porphyreolophus	porphyreolophus
624123	"Hector Spruit"	South Africa: Mpumalanga Prov.	25° 26'S	31° 41'E	porphyreolophus	chlorochlamys
200089	"Berea, near Durban, Natal"	South Africa: KwaZulu-Natal Prov.	29° 51'S	31° 00'E	porphyreolophus	
111234	"Durban, Natal South Africa"	South Africa: KwaZulu-Natal Prov.	29° 53'S	31° 03'E	porphyreolophus	
624125	"Port Natal"	South Africa: KwaZulu-Natal Prov.	29° 53'S	31° 03'E	porphyreolophus	

APPENDIX 4 *continued*

Voucher <sup>a</sup>	Label locality	Current administrative division	Latitude	Longitude	Phenotype	ND2 haplotype
624124	"Illovo 20 miles west of Durban, Natal"	South Africa: KwaZulu-Natal Prov.	30° 04' S	30° 50' E	porphyreolophus	
176644	"Umzumbwe Mission" Natal	South Africa: KwaZulu-Natal Prov.	30° 37' S	30° 33' E	porphyreolophus	porphyreolophus
50074	Natal, S. Africa	South Africa: KwaZulu-Natal Prov.	>29° S	?	porphyreolophus	
50078	"Natal, So. Afr."	South Africa: KwaZulu-Natal Prov.	>29° S	?	porphyreolophus	porphyreolophus

<sup>a</sup> AMNH unless specified.







All issues of *Novitates* and *Bulletin* are available on the web (<http://digitallibrary.amnh.org/dspace>). Order printed copies on the web from:

<http://shop.amnh.org/a701/shop-by-category/books/scientific-publications.html>

or via standard mail from:

American Museum of Natural History—Scientific Publications  
Central Park West at 79th Street  
New York, NY 10024

Ⓒ This paper meets the requirements of ANSI/NISO Z39.48-1992 (permanence of paper).